

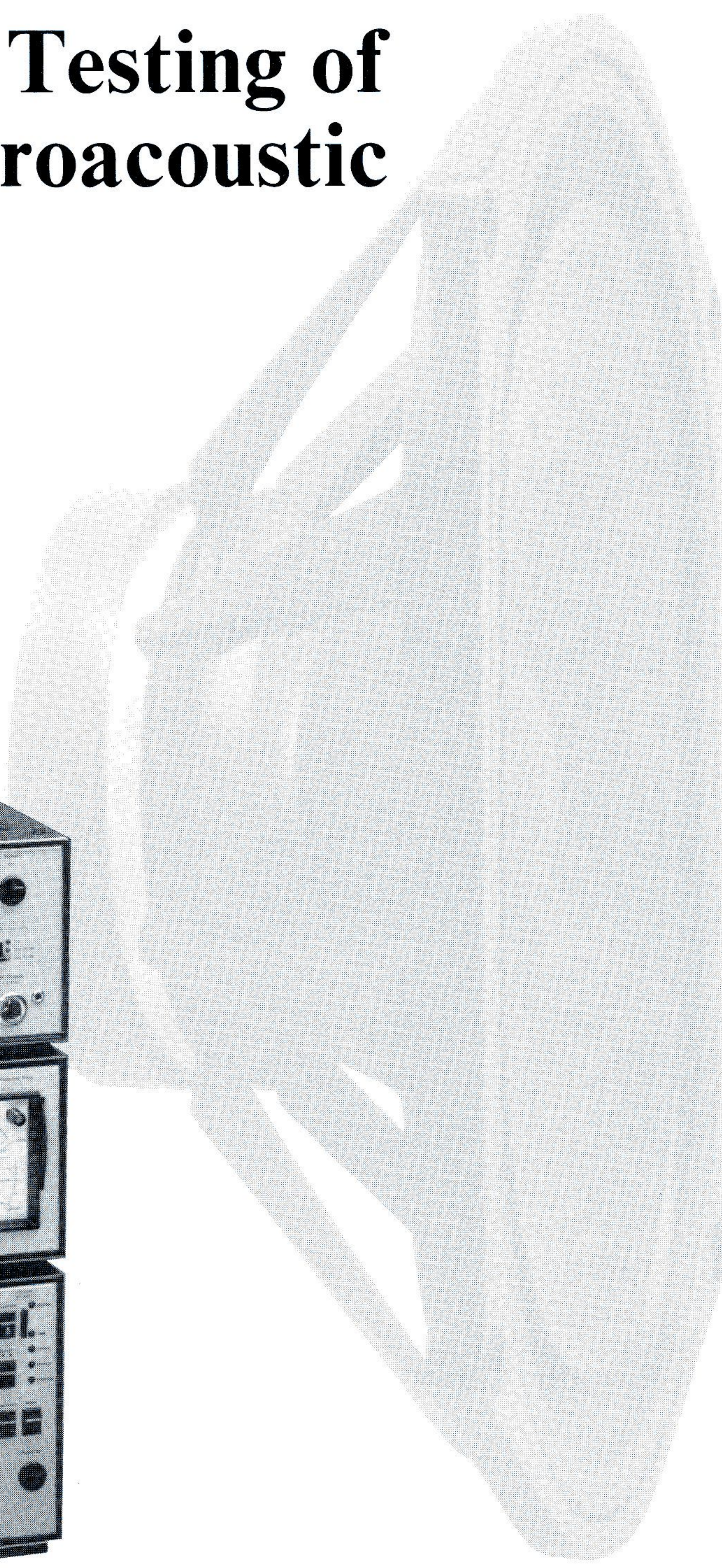

Automatic Quality Testing of Loudspeaker Electroacoustic Performance

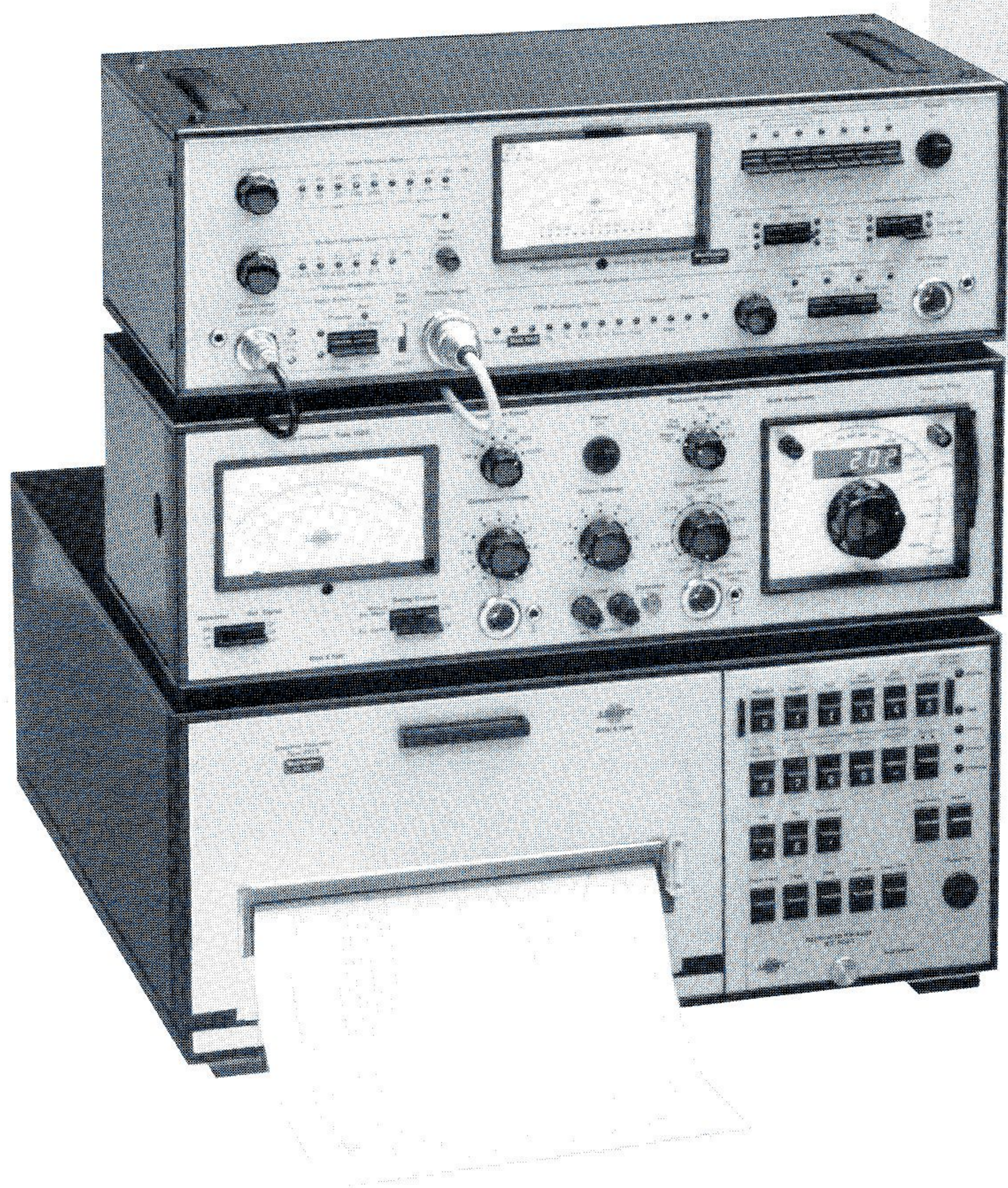

Automatic Quality Testing of Loudspeaker Electroacoustic Performance

by John R. Bareham, Brüel & Kjær

This Application Note is based on a paper presented at the Society for Automotive Engineers (SAE) International Congress and Exposition in Detroit, Michigan, February 24th, 1986.

The electroacoustic performance of loudspeakers can be tested by automatic instrumentation. A battery of tests can be designed to detect most major faults, compare to previously defined limits, and automatically yield a pass or fail indication. The battery may include tests for frequency response, sensitivity, rubbing voice coils, buzzing or rattling structures, loose particles, motor and cone distortion, polarity and impedance. Observations can be made about how each test correlates to audibly perceived quality. Although pass/fail criteria will be different for each type of loudspeaker, general guidelines can be given. The design and implementation of the tests will be described, and examples will be shown for both good and bad loudspeakers.

In many loudspeaker factories, skilled operators listen to hundreds of loudspeakers daily to detect faults such as rubbing voice coils, buzzing or rattling, loose particles in the gap, and some types of distortion. The operators may also look at an oscilloscope screen to check frequency response and/or polarity. The system works, but there are several obvious disadvantages. A more rational and repeatable system can be developed using automatic instrumentation for outgoing or incoming quality testing.

The characteristics which describe the electroacoustic performance of a loudspeaker can be loosely divided into two groups. The first group includes frequency response, sensitivity, absolute polarity and impedance. There are several ways of measuring each of these objective parameters, but most are relatively straightforward. Once each of these parameters is measured, little interpretation is needed. With the exception of polari-

ty, these measured values can vary both above and below the design standard. If they fall within manufacturing tolerances, the loudspeaker is acceptable.

The second group of characteristics includes unwanted sounds such as rubbing voice coils, buzzing or rattling, loose particles in the gap, and various other kinds of obviously audible distortion. It's quite a challenge to define measurable parameters which correlate well with these subjective characteristics. Interpreting such measurements and setting tolerances is also difficult. Of course, a good speaker would have none of the above unwanted sounds, so a lower limit is not necessary. But the upper limit depends largely on audibility, which is also subjective. Devising instrumented tests for the above subjective characteristics requires a good deal of experimental work, both to define the useful measurements as well as to set appropriate upper limits.

Measurement techniques used for quality testing can be quite different from measurements used in research and development. The quality test need only determine if the objective characteristics of the unit under test are sufficiently like the design standard and if unwanted subjective characteristics are sufficiently low. Since quality tests will be compared to the design standard as a reference, absolute measurements are not required.

As an example, consider the free-field frequency response of the design standard. The speaker may be mounted on a baffle or in an enclosure, to simulate actual use. The measurement may be made in an anechoic room, or it may be measured in an ordinary room using simulated free-field techniques.

In either case, the true free-field frequency response will be measured. On the testing line, however, the measurements can be made much more simply, as long as the results are consistent. The design standard is first measured using the simple technique, and then the units under test are compared to it using exactly the same technique. If they measure the same in the simpler test set-up, then their true free-field response is the same.

For most loudspeakers, a near-field test set-up will be quite satisfactory. The measuring microphone is placed very close to the speaker, perhaps $\frac{1}{2}$ " from the front plane (Fig. 1). The speaker can be mounted on a small baffle or even in a small sound isolation box, although this is often unnecessary.

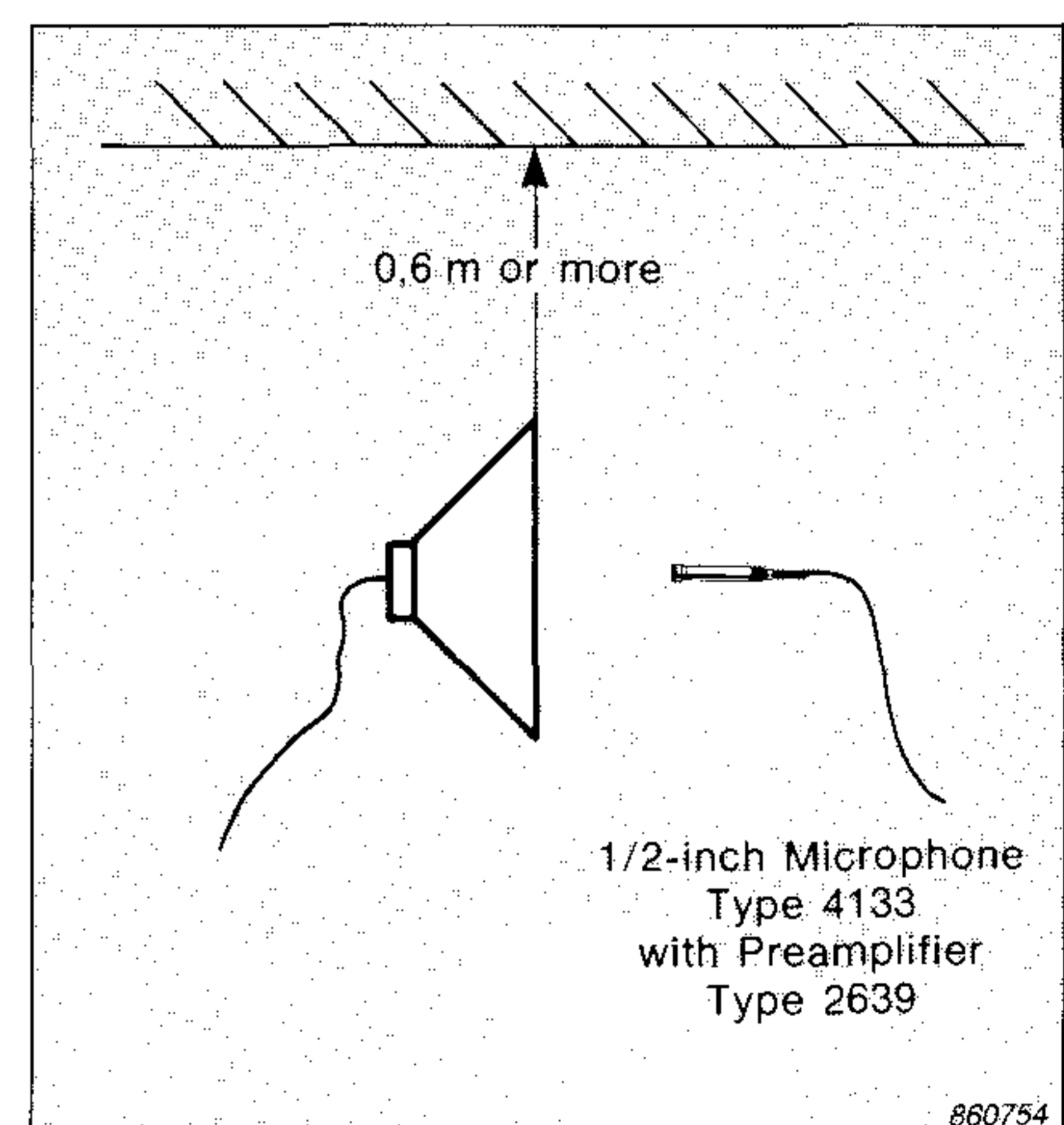

Fig. 1. Near-field measurement set-up. Open area, no baffle. Microphone is $\sim \frac{1}{2}$ " from front of speaker, on axis

There are several advantages to the near-field set-up. It is very simple and inexpensive. If the test jig is stable, the measurements are quite repeat-

able. The sound level at the microphone is quite high, so contamination from background noise is minimized (Fig. 2). As long as there are no hard reflecting surfaces nearby, room reflections will also have little influence. The path length from loudspeaker to reflection to microphone is much longer than the $\frac{1}{2}$ " path from speaker to microphone, so the relative level of the reflection will be much lower.

Just as there are many specific things that can go wrong with an automobile, there are many separate things that can go wrong with a loudspeaker. A dead battery or a flat tire could each keep a car from moving, but you have to look in two different places to be sure there is no problem. Low sensitivity or a rubbing voice coil could each ruin a loudspeaker, but a different test is required for each fault. After reading the descriptions of the several tests that follow, it should be clear that a battery of tests is needed to weed out unacceptable loudspeakers.

The examples that follow are near-field measurements made without baffle or box. The loudspeakers are all fairly conventional paper-cone electrodynamic loudspeakers from 3" diameter to 6" \times 9", made by several different manufacturers. Some speakers tested had whizzer cones, coaxially mounted tweeters and/or dust covers.

The tolerance limits used in the following measurements of objective characteristics such as frequency response, sensitivity, polarity and impedance are completely arbitrary; they serve only to illustrate the technique. However in measurements relating to the subjective characteristics collectively labeled "unwanted sounds", the tolerances were chosen experimentally to suggest what is or is not audible, at least to my ear.

Frequency response can be measured using sine, noise or impulse test signals. The main appeal of using noise or impulse signals is that the entire spectrum, or at least one decade, can be measured at once, apparently reducing measurement time. However, once such factors as averaging time, crest factor of the test signal and signal-to-noise ratio are all taken into account, the measuring time may not be as short as first hoped. In the measurements described here, sinewave test signals were used, since they are required for distortion and

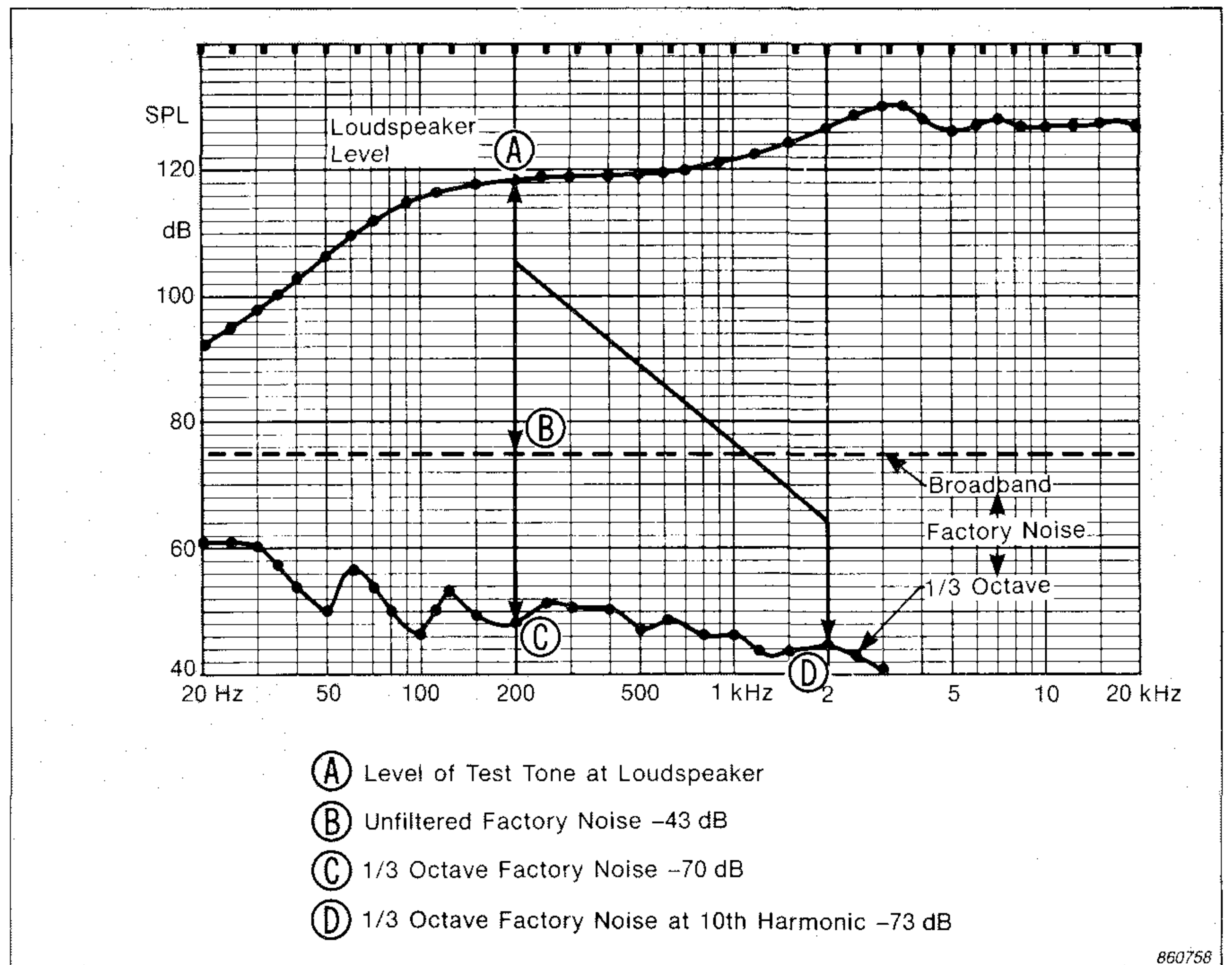

Fig. 2. Influence of factory noise on near-field loudspeaker measurement

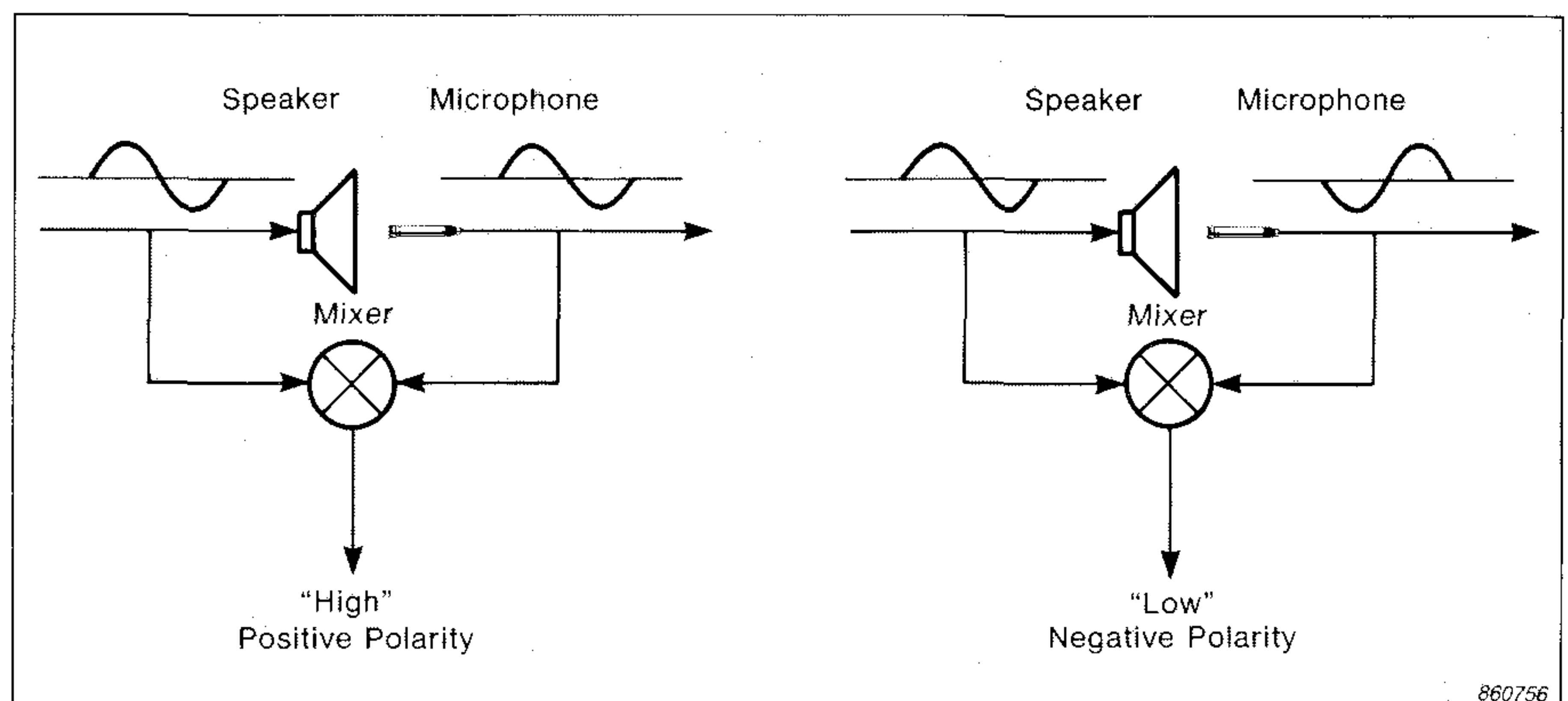

Fig. 3. Polarity test at selected frequency

other measurements to follow. An adaptive sampling routine is used to reduce measuring time at each test point to an absolute minimum, while maintaining a specified accuracy.

The near-field frequency response measurement is shown in Fig. 4. The frequency step size is $\frac{1}{12}$ octave, or approximately 6%. The tolerance curve was made by taking a similar measurement of an actual loudspeaker, reducing the data to $\frac{1}{3}$ octave points, and specifying a tolerance window of $\pm x$ dB. Arbitrary tolerances could have been entered instead, in $\frac{1}{3}$ octaves.

From the same measurement, sensitivity is calculated. In this case a user-definable "weighting curve" is used to select the measured levels at 315, 400 and 500 Hz. These levels are then power averaged and displayed as "loudness rating". Note that an independent tolerance has been placed on this measure of sensitivity.

Polarity can be tested in many ways, including DC voltage, impulse or lissajou patterns on an oscilloscope. In these tests the scheme of Fig. 3 is used. It is basically a one-bit phase-meter operating at a user-defined frequency. This results in a simple, un-

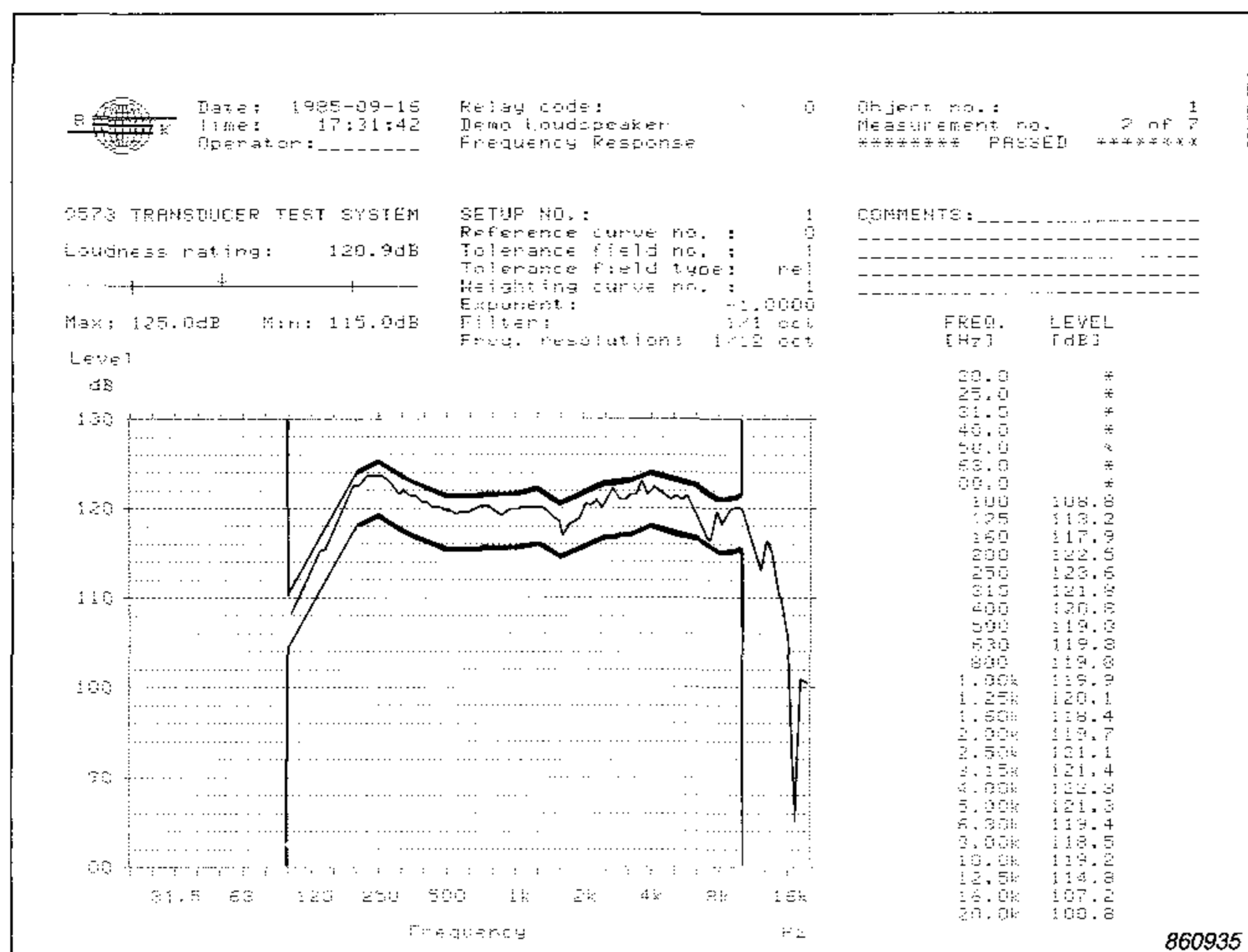

Fig. 4. Near-field frequency response, shown with tolerance mask. "Loudness Rating" is sensitivity average of 315, 400 and 500 Hz

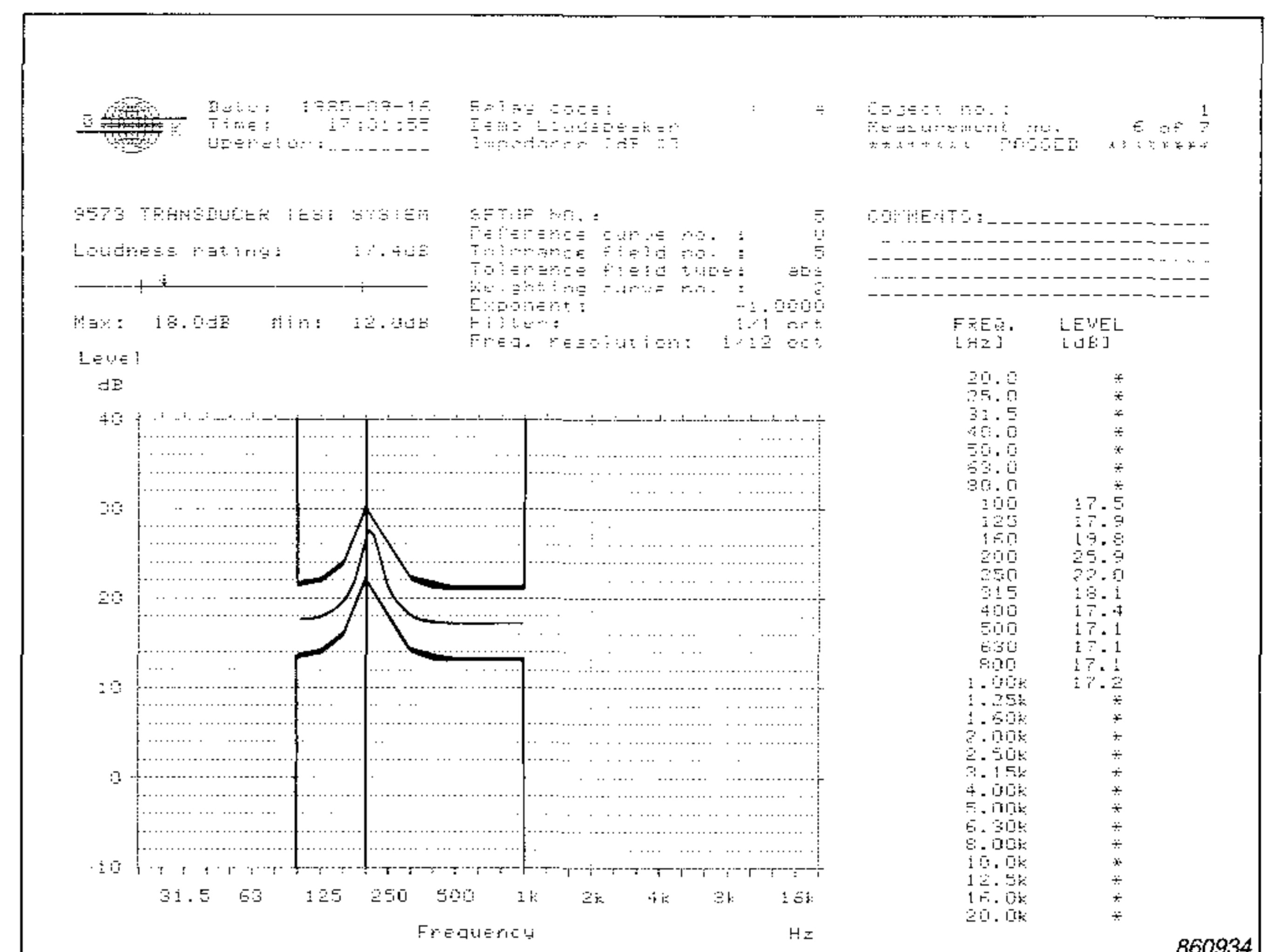

Fig. 5. Electrical impedance magnitude in "dB ohms" (0 dB = 1 Ω, 6 dB = 2 Ω, 12 dB = 4 Ω, etc.). "Loudness Rating" is |z| at 400 Hz

ambiguous measurement which is easily automated. It also allows the possibility of performing separate polarity tests on each driver of a coaxial or triaxial speaker, simply by selecting the appropriate frequency for each driver.

A complete measurement of the magnitude and phase of a loudspeaker's electrical impedance across its entire frequency range is an important measurement for R & D work. For quality testing, it is usually sufficient to measure the impedance magnitude near resonance, or at one frequency well above resonance where the impedance is mostly resistive and varies little with frequency. The measurement can be performed in many ways, but the simple method shown in Fig. 6 is used here, giving the results shown in Fig. 5.

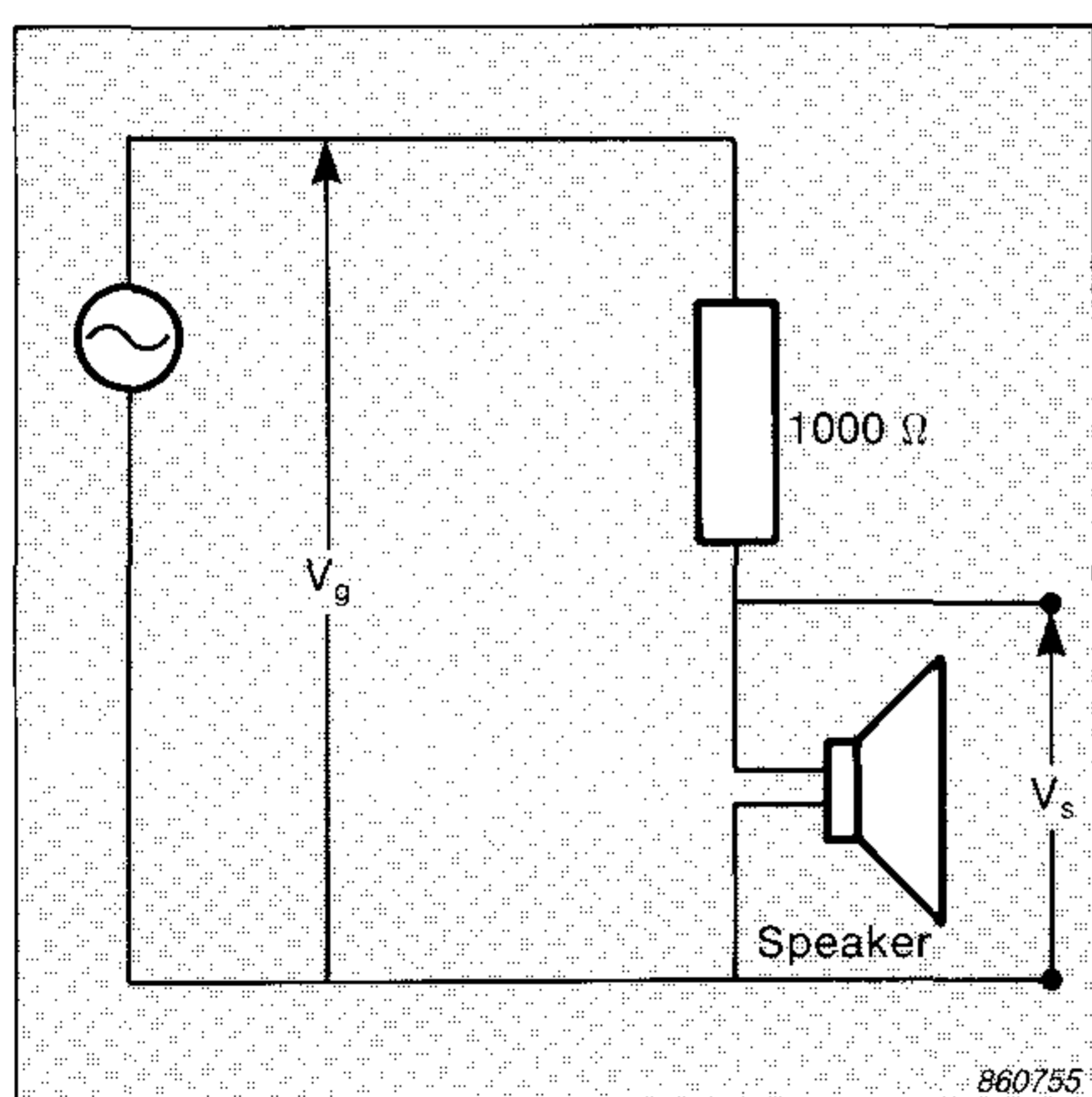

Fig. 6. Impedance measurement using series resistor.

$$\text{Speaker impedance } |z| = \frac{1000 V_s}{V_g}$$

A rubbing voice coil cannot be detected from the loudspeaker's frequency response (Fig. 7). However if a sinewave is applied to the speaker and the acoustic output measured with a spectrum analyzer, the difference between a good and a rubbing speaker is clear (Fig. 8). The part of the spectrum which clearly differentiates between good and bad loudspeakers is typically from the 6th harmonic on up, higher than one might ordinarily look. The levels of these higher order harmonics can be 10 to 30 dB greater in a bad speaker than in a good one. However, these levels will usually be much less than 2nd and 3rd order distortion. Therefore, a simple measurement of Total Harmonic Distortion (THD) will not detect the flaw. The instrumentation must be able to select an ensemble of high order harmonics, and it must be able to measure them at levels roughly 70 dB below the fundamental sinewave test tone.

Experiments with several loudspeakers show that an ensemble of harmonics somewhere between 6 and 22 usually correlate best to audibly perceived rub. If the level of these harmonics exceeds -60 dB, the rub is usually audible. However, both the most sensitive harmonics and the tolerance level corresponding to audibility will vary from one speaker design to the next. The test should therefore be optimized experimentally for each speaker type to be tested. In most cases, one test frequency near resonance is enough. This is suggested by the falling trend in the curves of Figs. 9 and 10, where the level of harmonics 7-9 is plotted as a function of

test frequency. This test is usually not strongly sensitive to the actual level of the applied test signal.

When a loudspeaker has a rattle, whether the rattle is due to a loose part or a cone defect, the spectrum is similar to that of a rub. The threshold of audibility is also similar, roughly -60 dB. However, in this case the rattle usually occurs only at one frequency. Therefore the test tone must be stepped through a wide enough range to excite any potential rattles, and the step size must be sufficiently small. Figs. 10, 11 and 12 suggest that 1/2 octave steps will work, but 1/3 octave steps will not. For the speakers shown, and all others tested in the experiment, a frequency range from resonance to roughly 400 Hz was sufficient. This may, of course, vary a little with different speaker designs. The rattle test is very sensitive to the test level. The speaker should be driven at the maximum permissible level to ensure exciting all potential rattles.

A loose particle in the gap of a loudspeaker excited by a sinewave generally produces a noise-like spectrum at frequencies much higher than the test tone (Figs. 13 and 14). The center frequency of the particle spectrum seems to depend on the speaker design, while the level depends on the size (or number) of the particle. The threshold of audibility again appears to be roughly -60 dB, or even lower.

Figs. 15 and 16 show decreasing particle noise as the test frequency increases. Since cone displacement decreases as frequency increases beyond

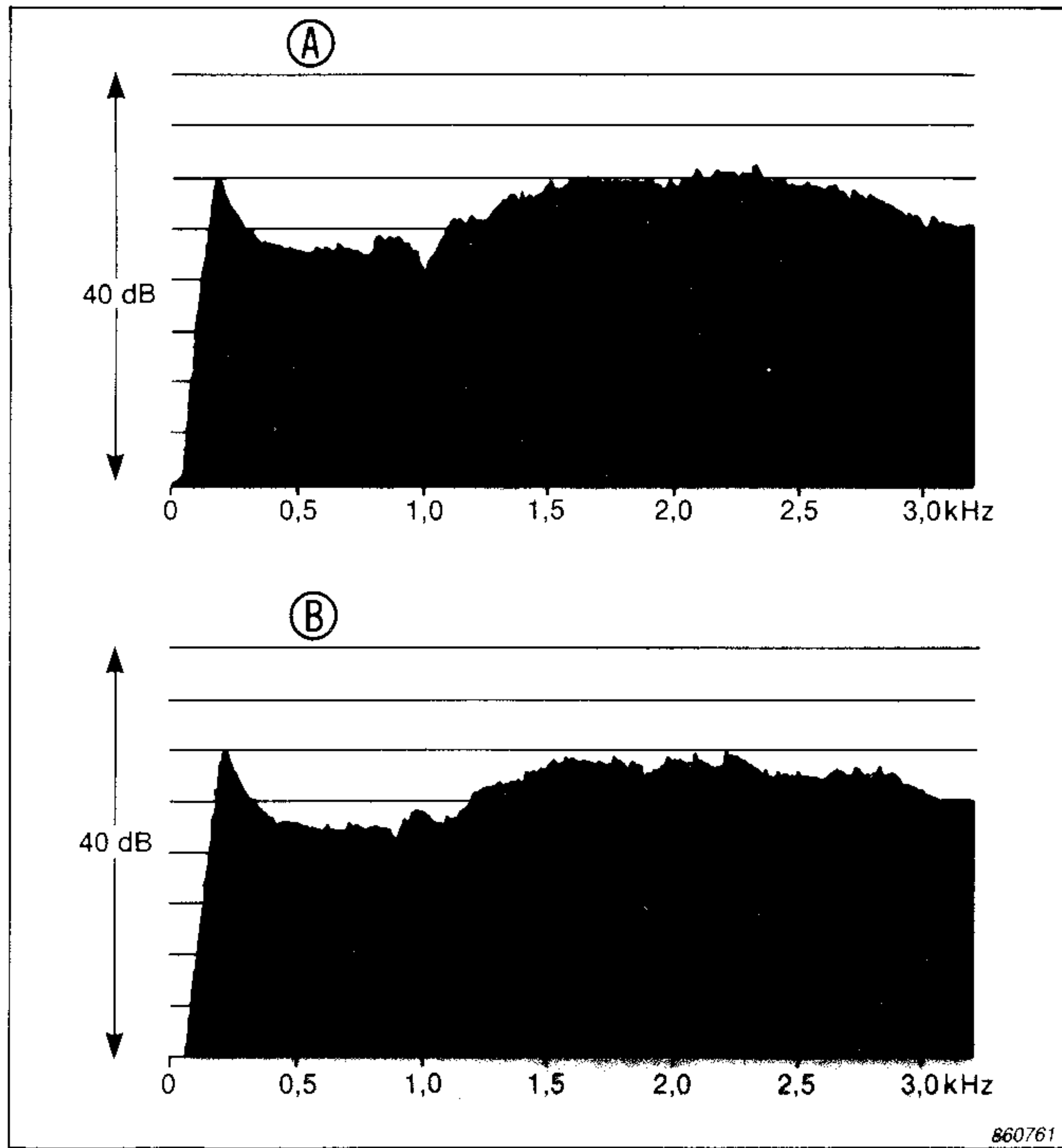

Fig. 7. Frequency response curves fail to show why speaker A sounds clear while speaker B has a noticeable rubbing sound

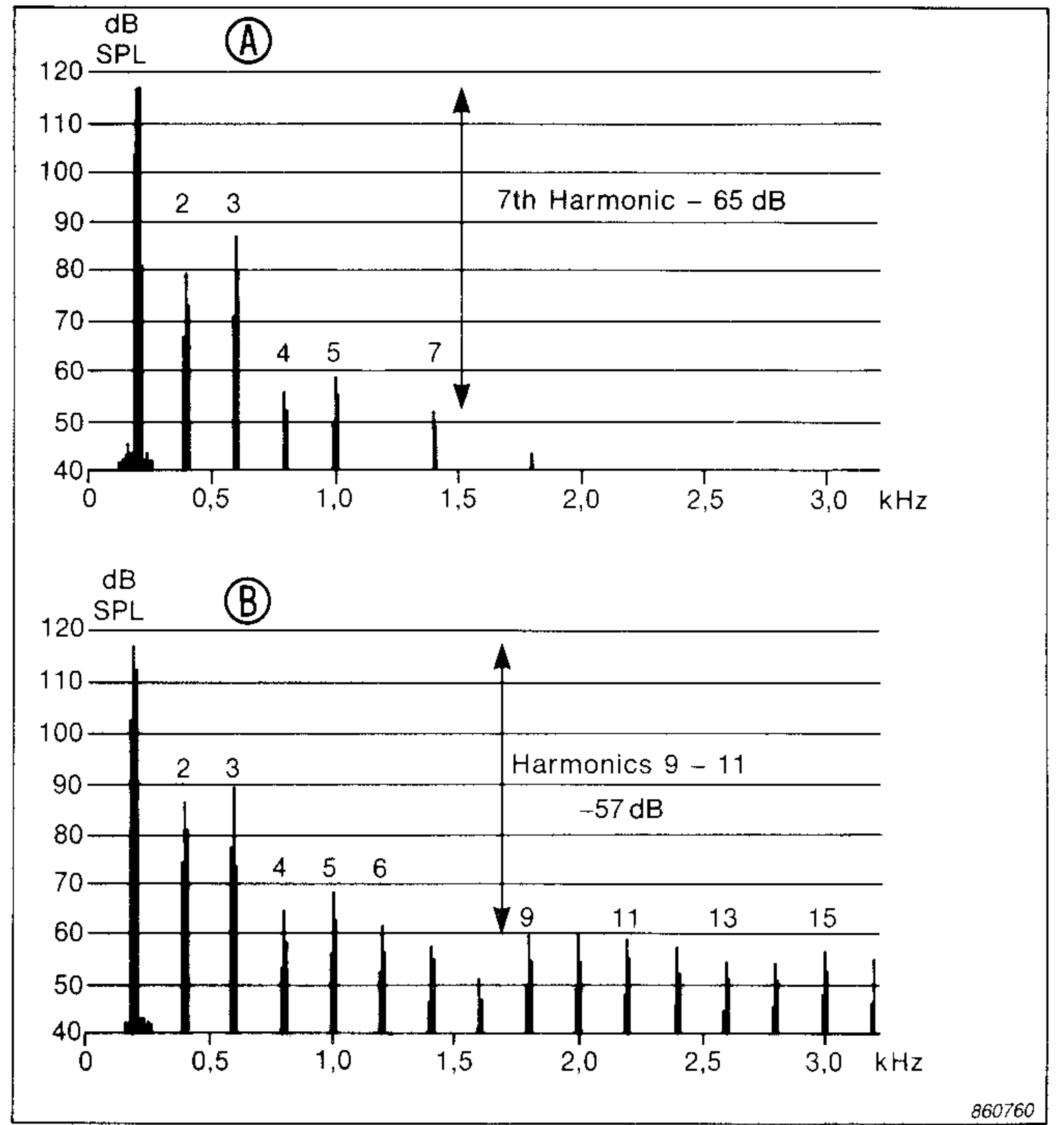

Fig. 8. Speaker A sounds clear. Most distortion is 2nd and 3rd harmonic. Speaker B has noticeable rubbing sound. Note increased level of harmonics 9 and up, while 2nd and 3rd harmonics show little difference from A

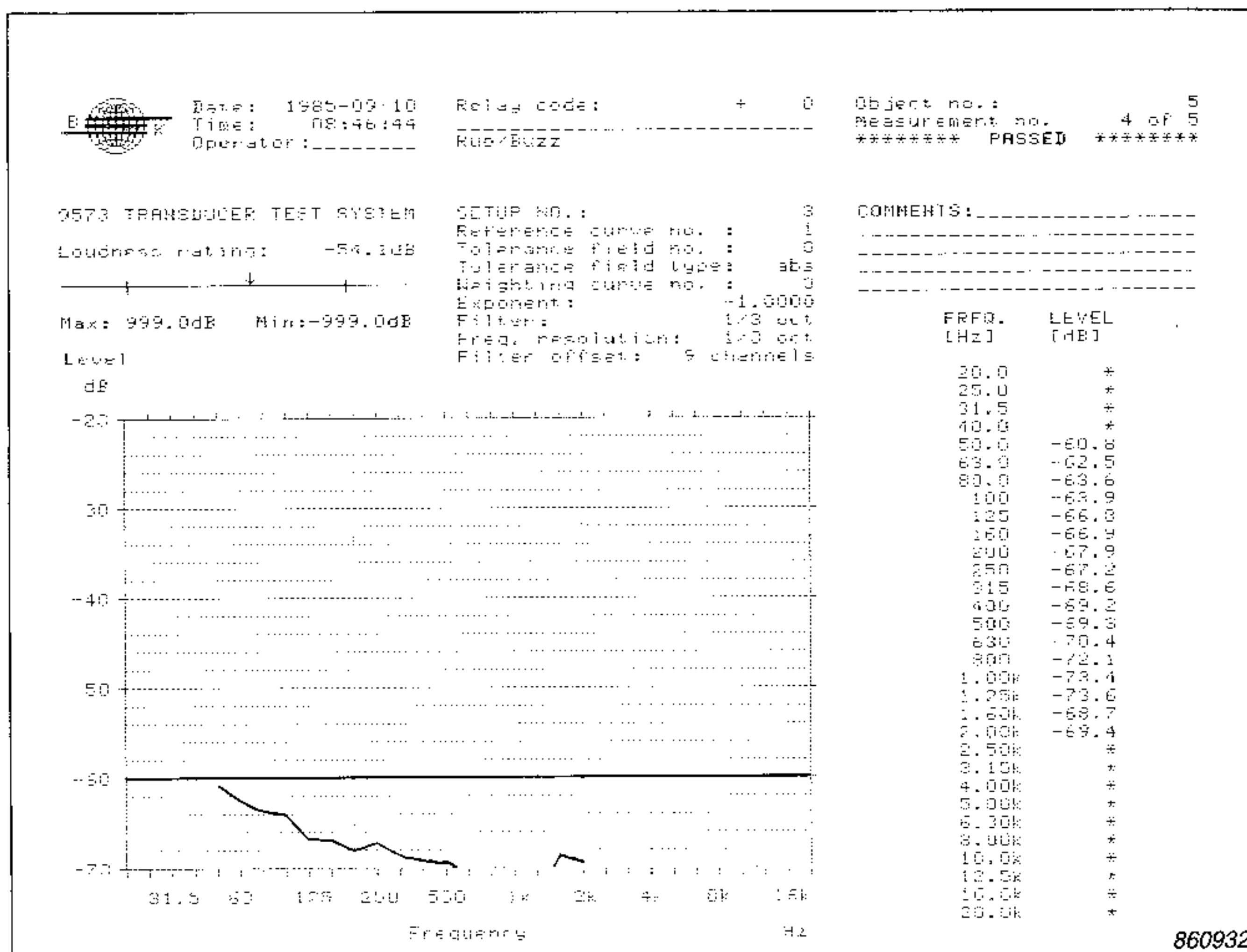

Fig. 9. Good speaker. Harmonics 7-9 less than -60 dB re fundamental (1/3 octave steps)

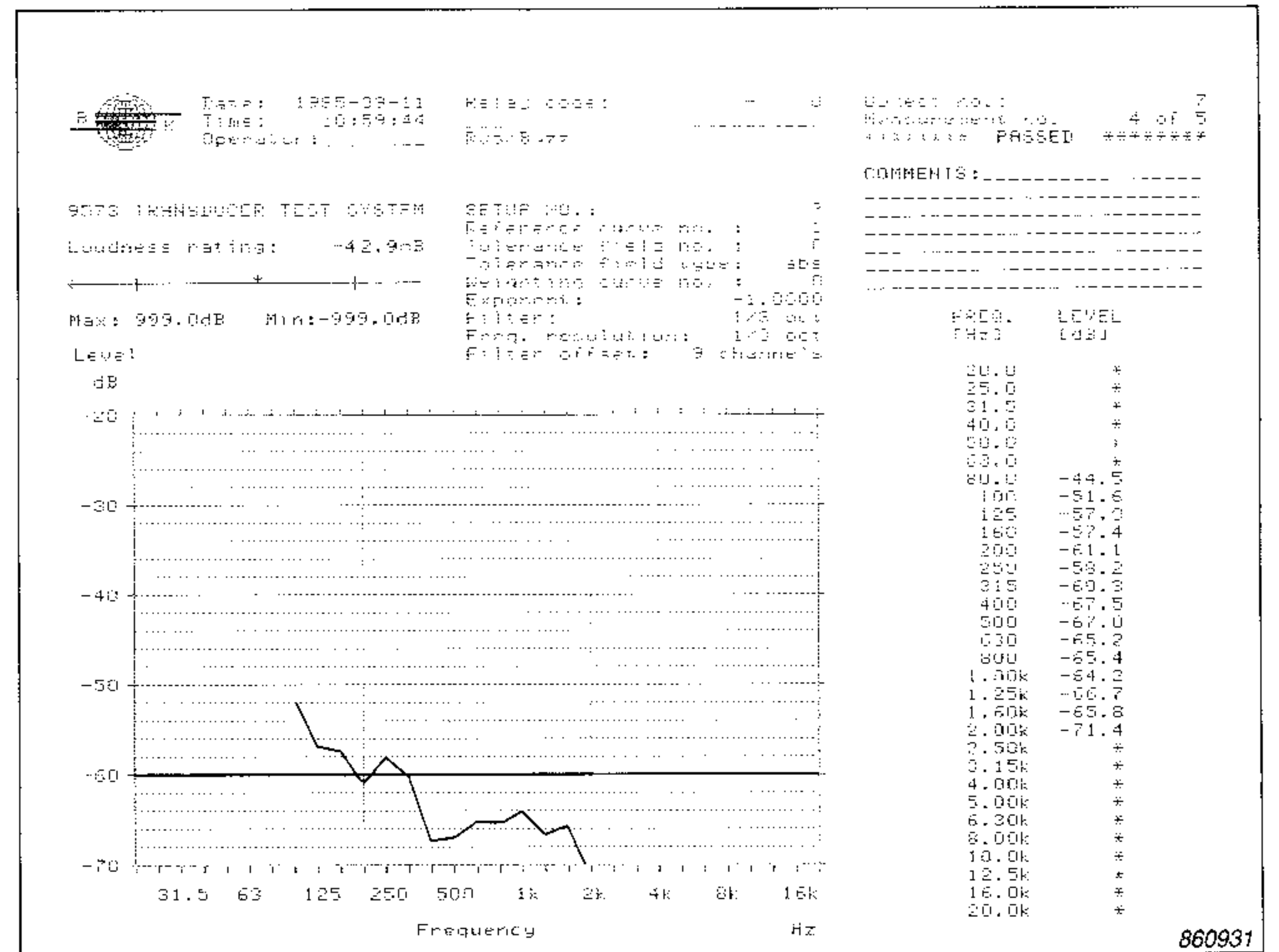

Fig. 10. Rubbing voice coil. Harmonics 7-9 well above -60 dB re fundamental (1/3 octave steps)

resonance, it is clear that maximum particle noise occurs at maximum cone displacement. Therefore, this test can be performed at just one frequency near resonance, but the level should be as high as possible.

Figs. 11 and 12 suggest that it may be possible to combine tests for rub

and buzz or rattle. However, it is usually not possible for such a combination test to reveal loose particles, since that defect usually appears at a completely different part of the spectrum.

Harmonic distortion in a loudspeaker can be caused by two general kinds of mechanisms. The basic motor struc-

ture, consisting of voice coil, magnet, gap and suspension, can become non-linear as cone displacement increases. Misaligned suspensions can also create distortion. These motor distortions increase with cone displacement, so they will be greatest at resonance and decrease as frequency goes up (Figs. 17, 18 and 19). Motor distortion

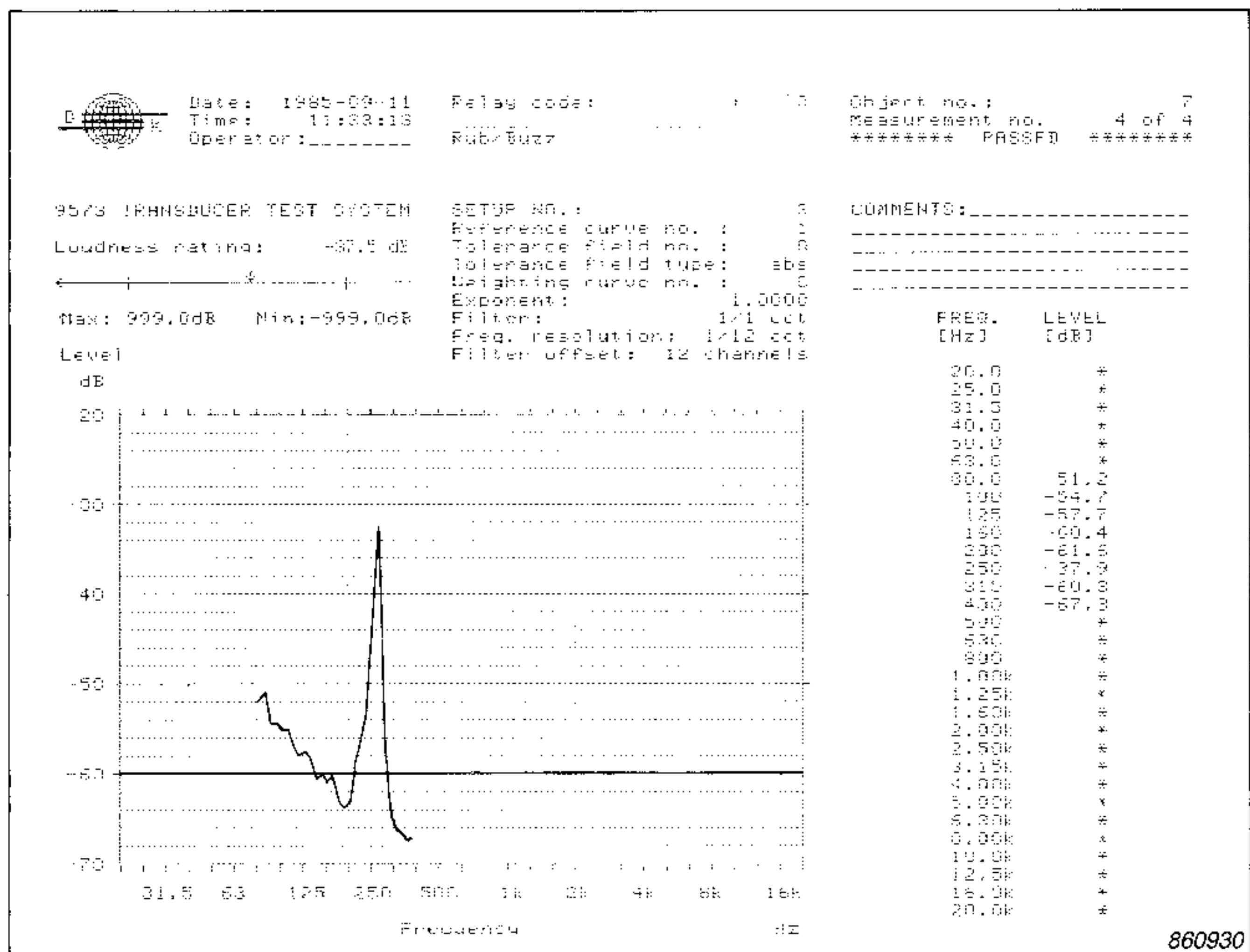

Fig. 11. Rattle in speaker frame, plus rub. Same speaker as Fig. 10. $1/12$ octave step size and tuning filter for harmonics 11-22 reveal rattle as well as rub

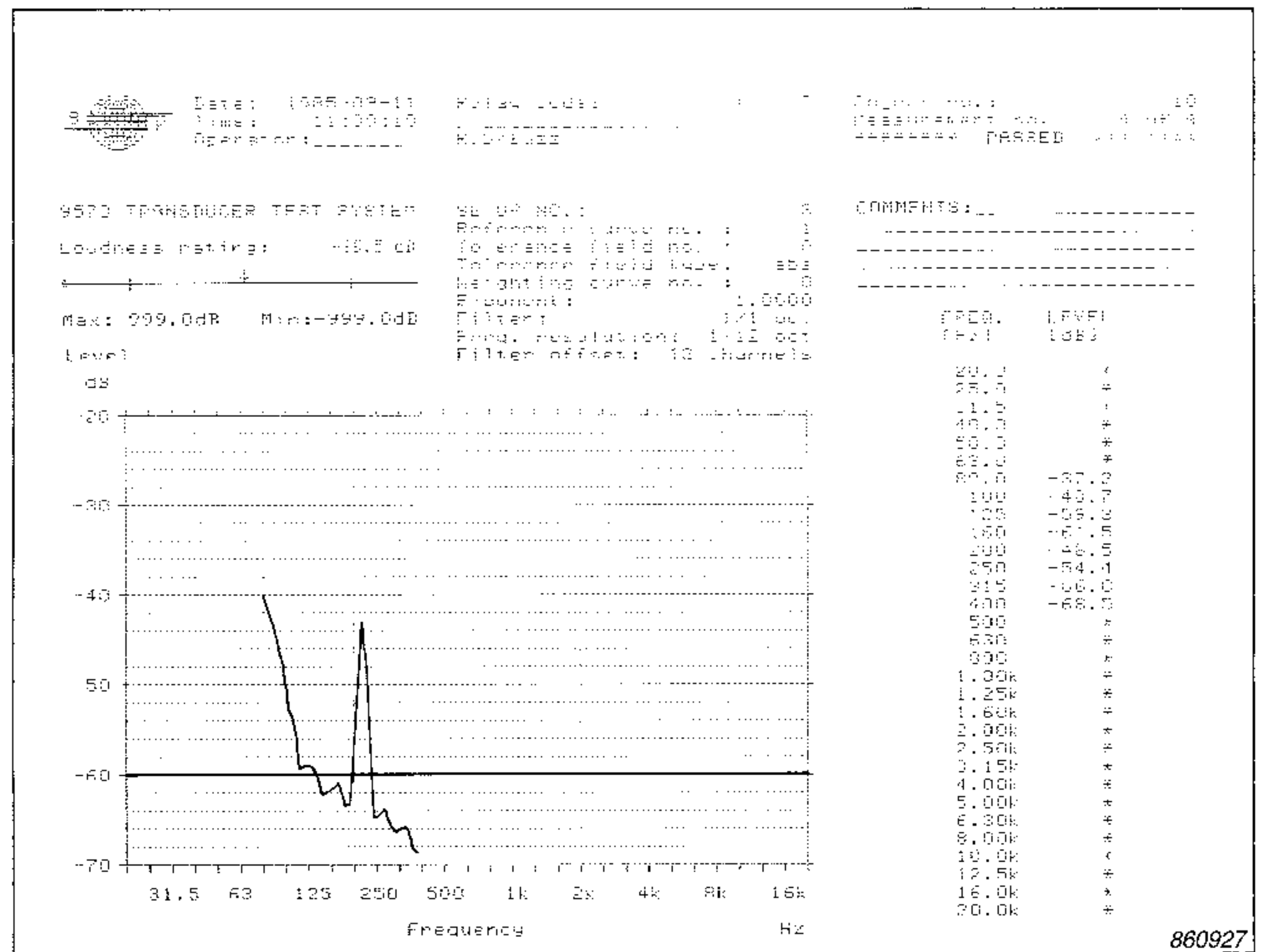

Fig. 12. Rattle in cone, plus rubbing voice coil. Harmonics 11-22, $1/12$ octave steps

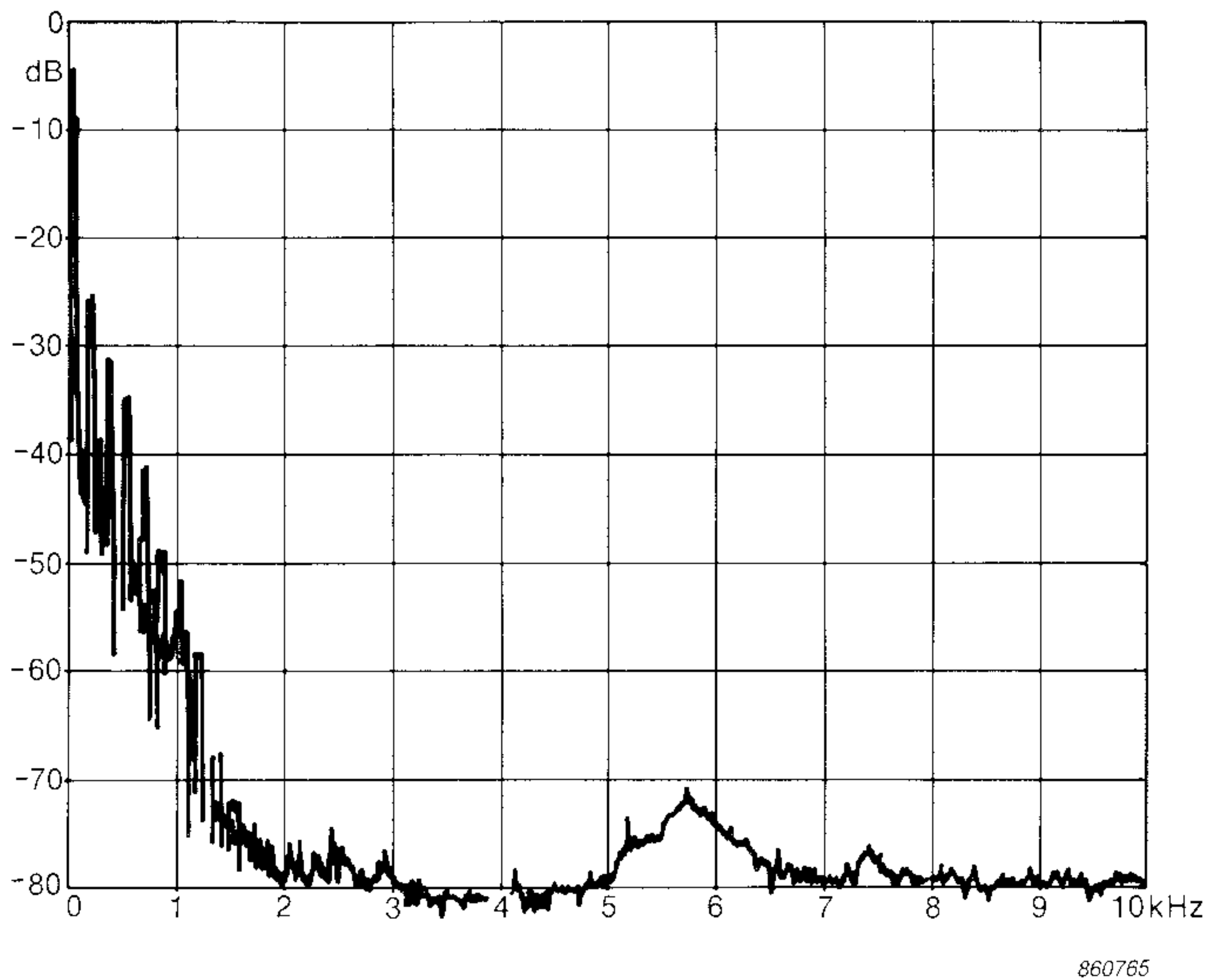

Fig. 13. Loudspeaker spectrum with noise-like peak near 6 kHz due to barely audible loose particle in gap (test tone 80 Hz)

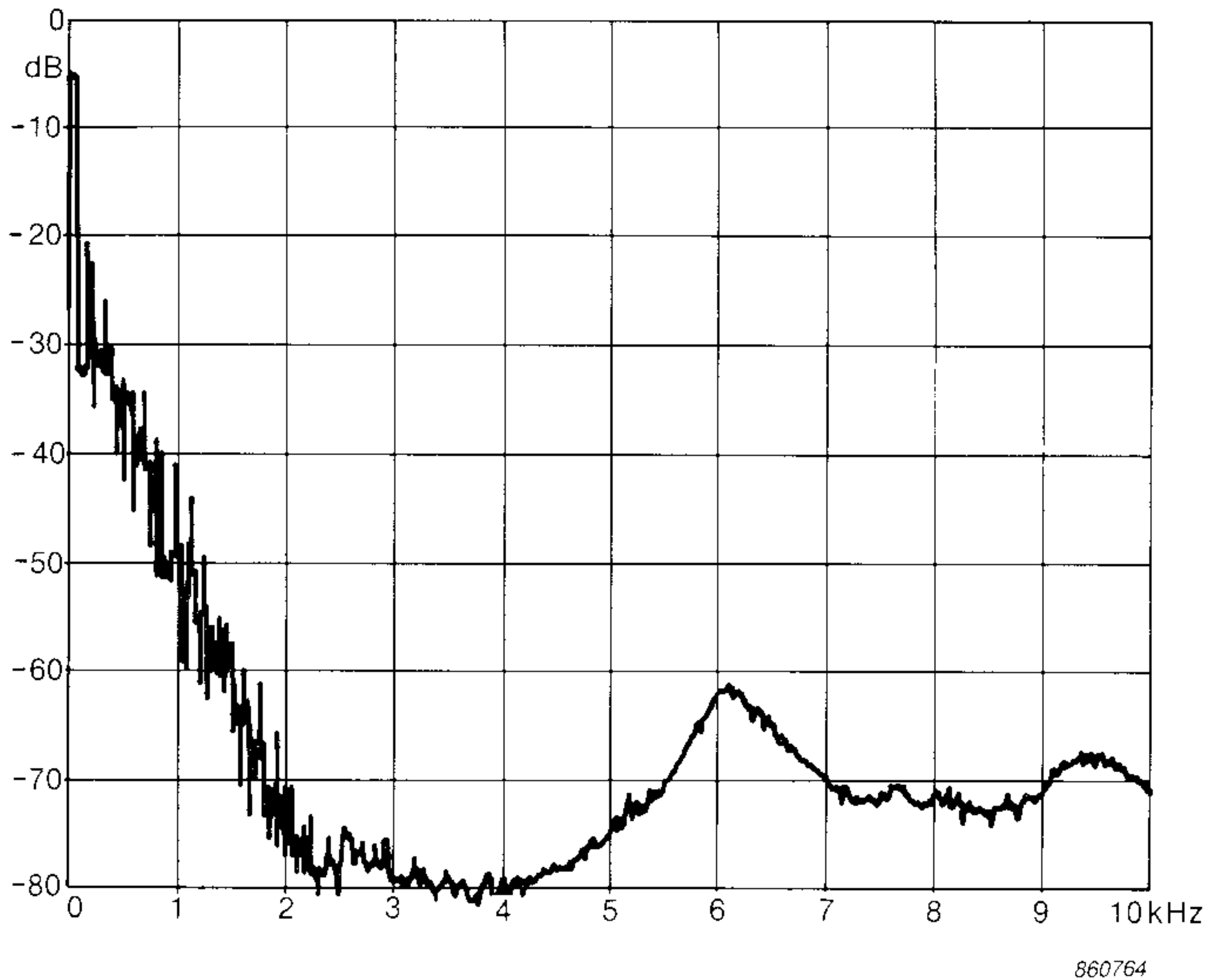

Fig. 14. Obviously audible loose particle (see Fig. 13)

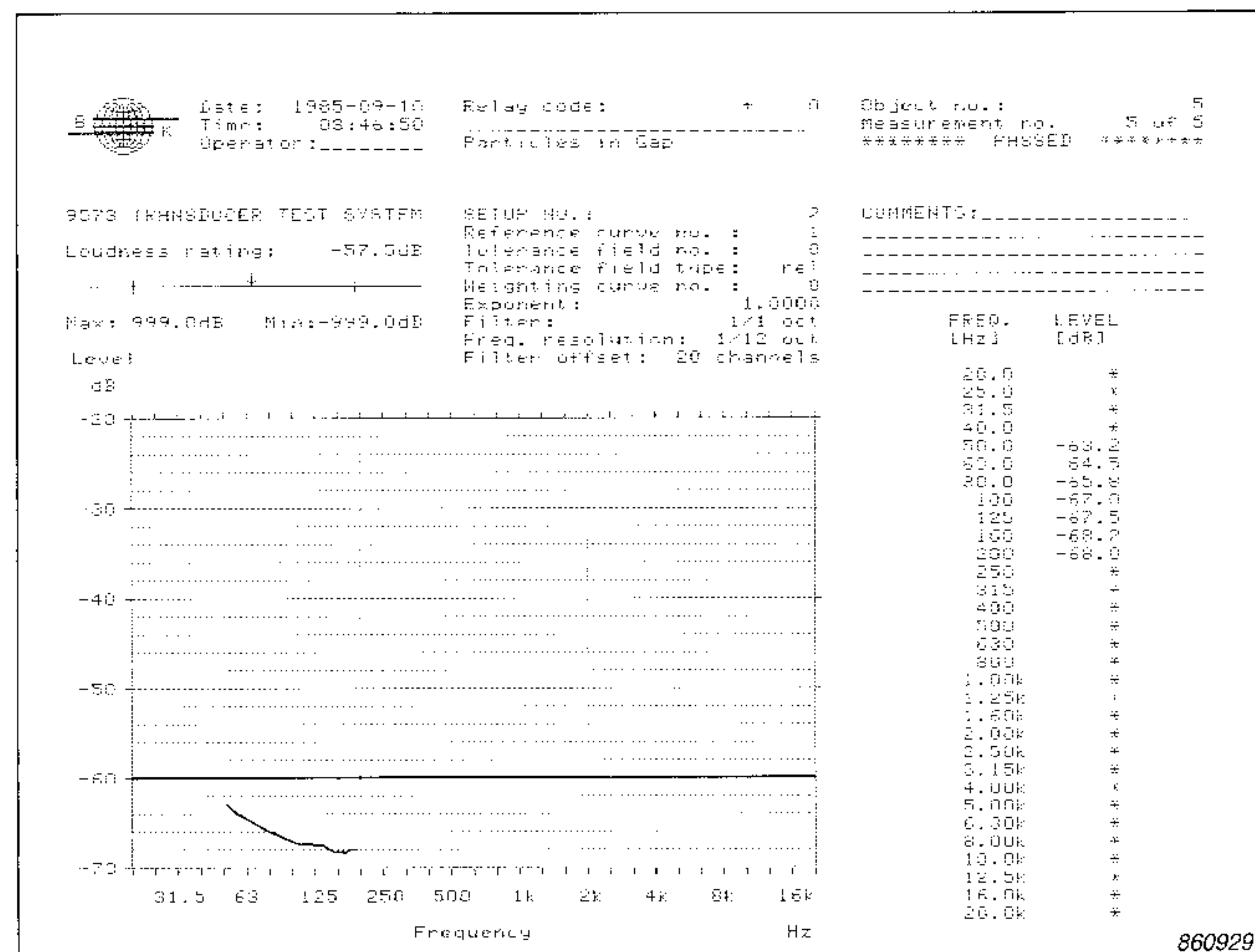

Fig. 15. Good speaker. Harmonics 71-141 below -60 dB

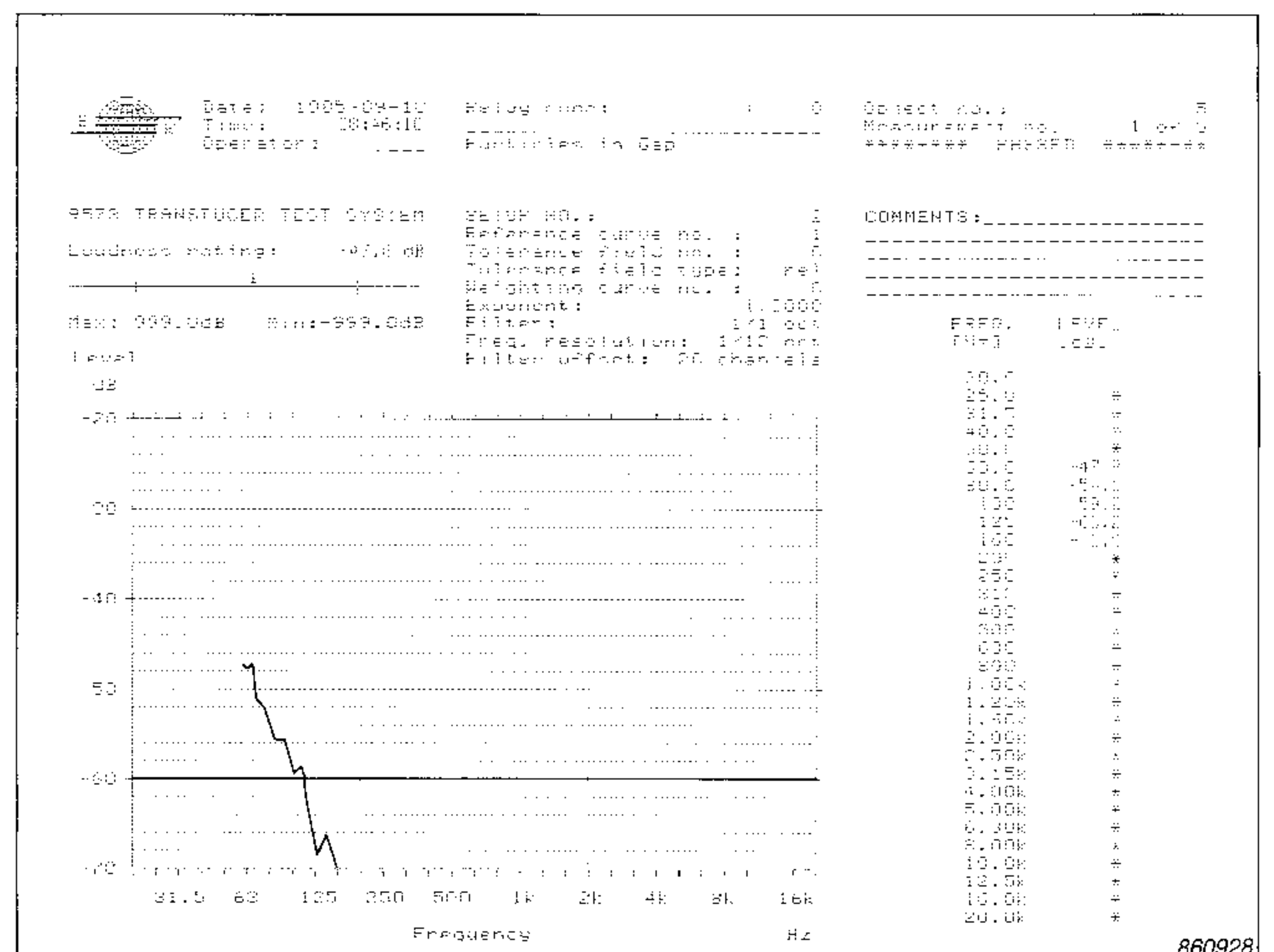

Fig. 16. Loose particles in gap. Harmonics 71-141 more than -60 dB near resonance

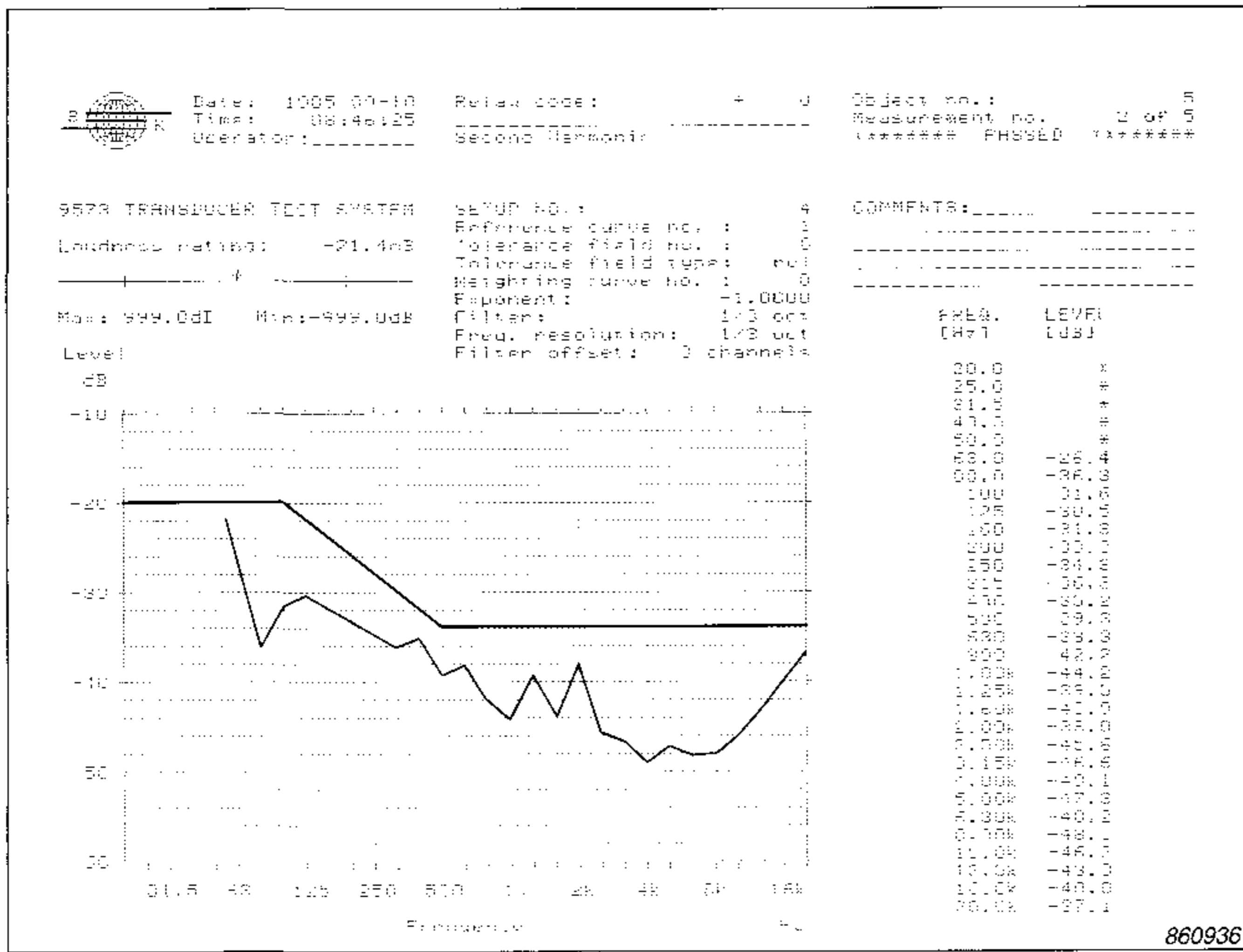

Fig. 17. Good speaker. 2nd harmonic below -20 dB at resonance, below -34 dB mid-band

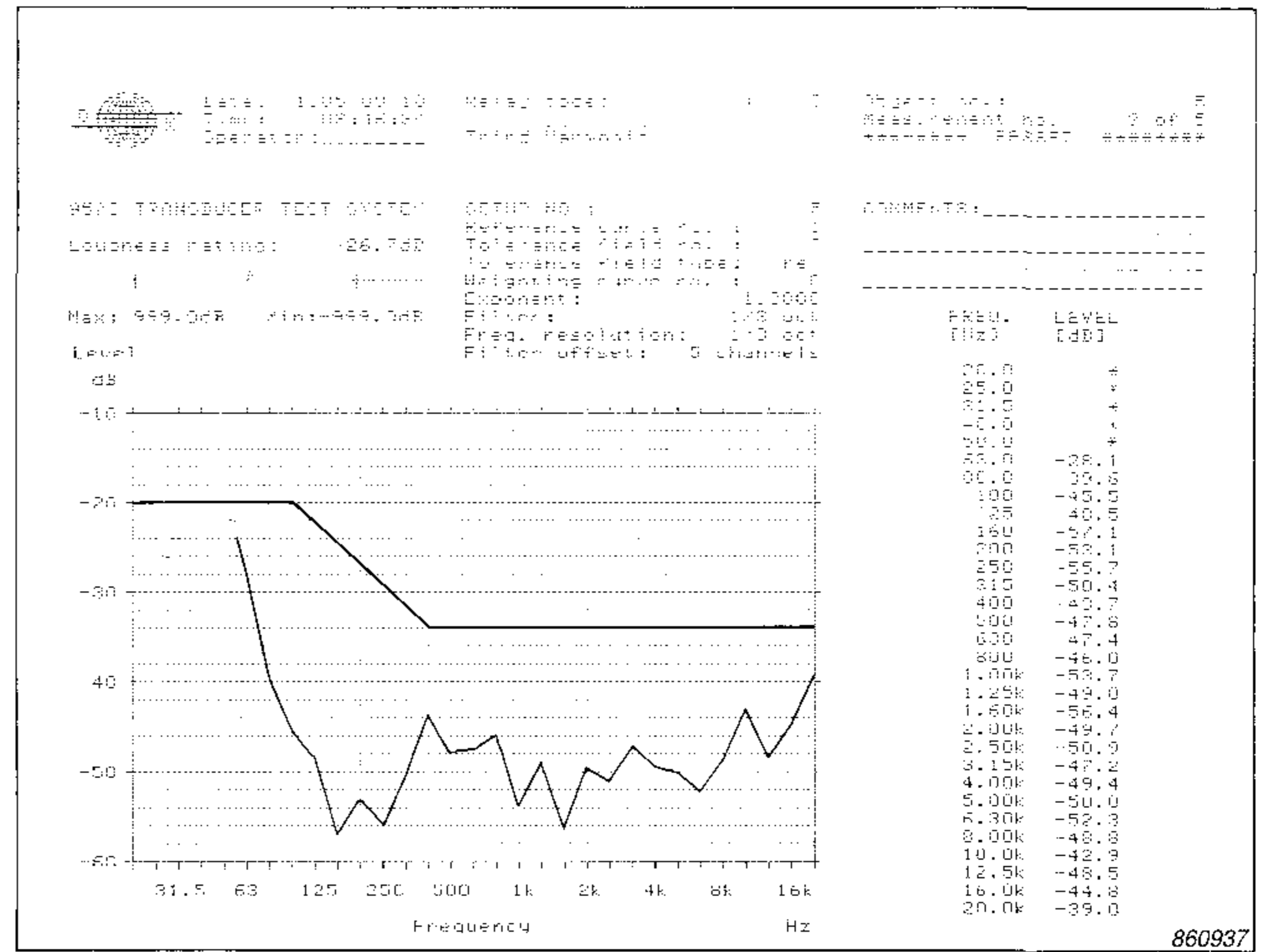

Fig. 18. Good speaker. 3rd harmonic below -20 dB at resonance, below -34 dB mid-band

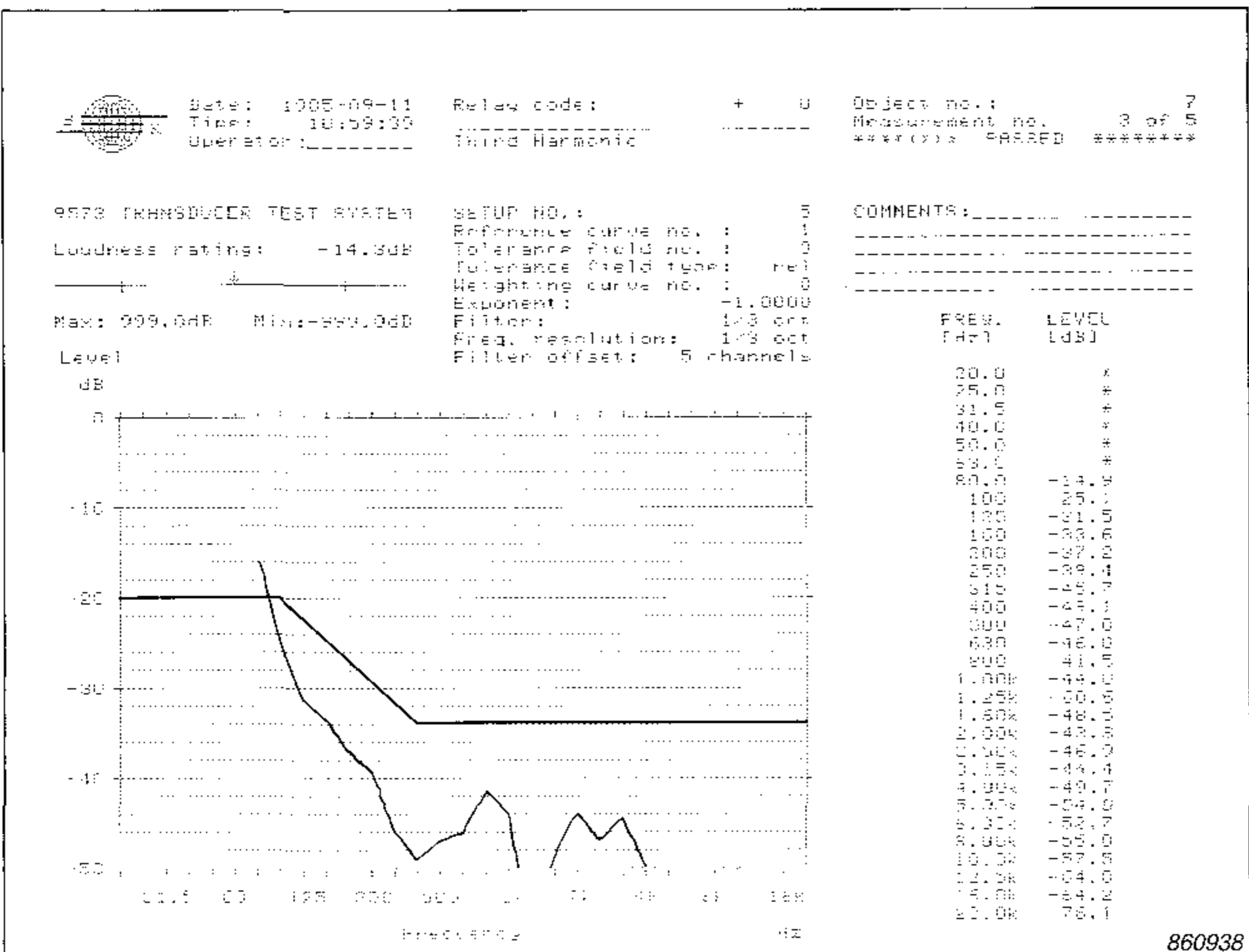

Fig. 19. Excessive motor distortion. 18% 3rd harmonic distortion at resonance, but ok elsewhere

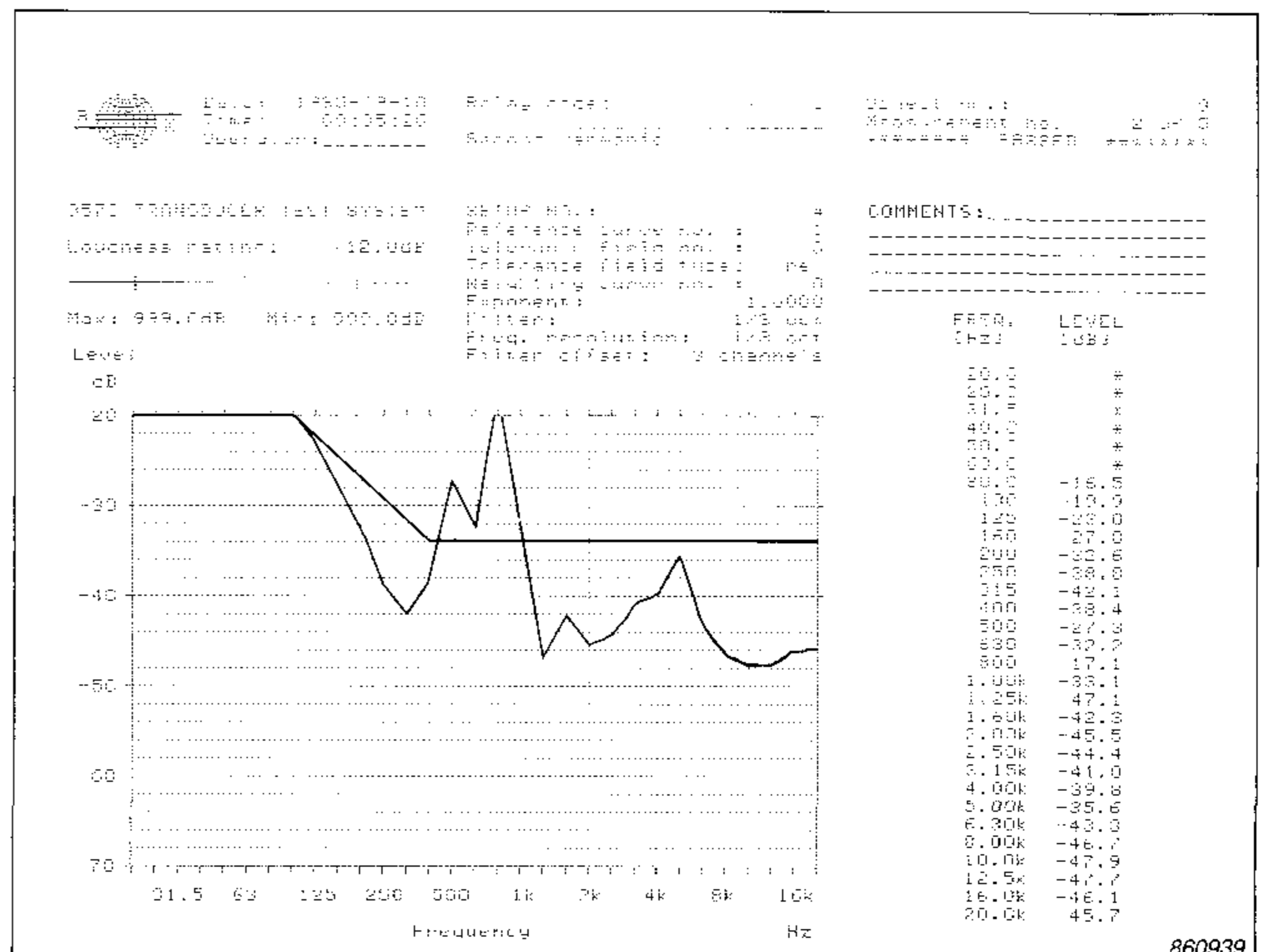

Fig. 20. Whistle-like cone distortion. 14% 2nd harmonic at 800 Hz

can therefore be evaluated by testing at resonance. Second and third harmonic distortion can be measured separately, or THD will also work in this case. The measured distortion is very dependant on test level. At high test levels, as much as 10% 2nd and 3rd harmonic distortion may be tolerable at resonance.

A second kind of distortion mechanism includes various problems in the

cone and outer suspension. These distortions usually occur at frequencies higher than resonance, depending quite a bit on the particular loudspeaker and the exact fault (Figs. 20-23), and generally increase with test level, though not always. Detection requires coverage of a range of frequencies, perhaps 250 - 1000 Hz, depending on the loudspeaker. For these "cone distortions" levels in the range of 2% can be plainly audible.

All the tests described above can be automated. The basic principle is shown in Fig. 25. The filter selects either the fundamental test frequency, harmonics, or ensembles of harmonics. This simple system can perform all the tests described manually. In fact, it is often valuable to use a manual system to determine the exact test parameters to be used in testing a particular loudspeaker.

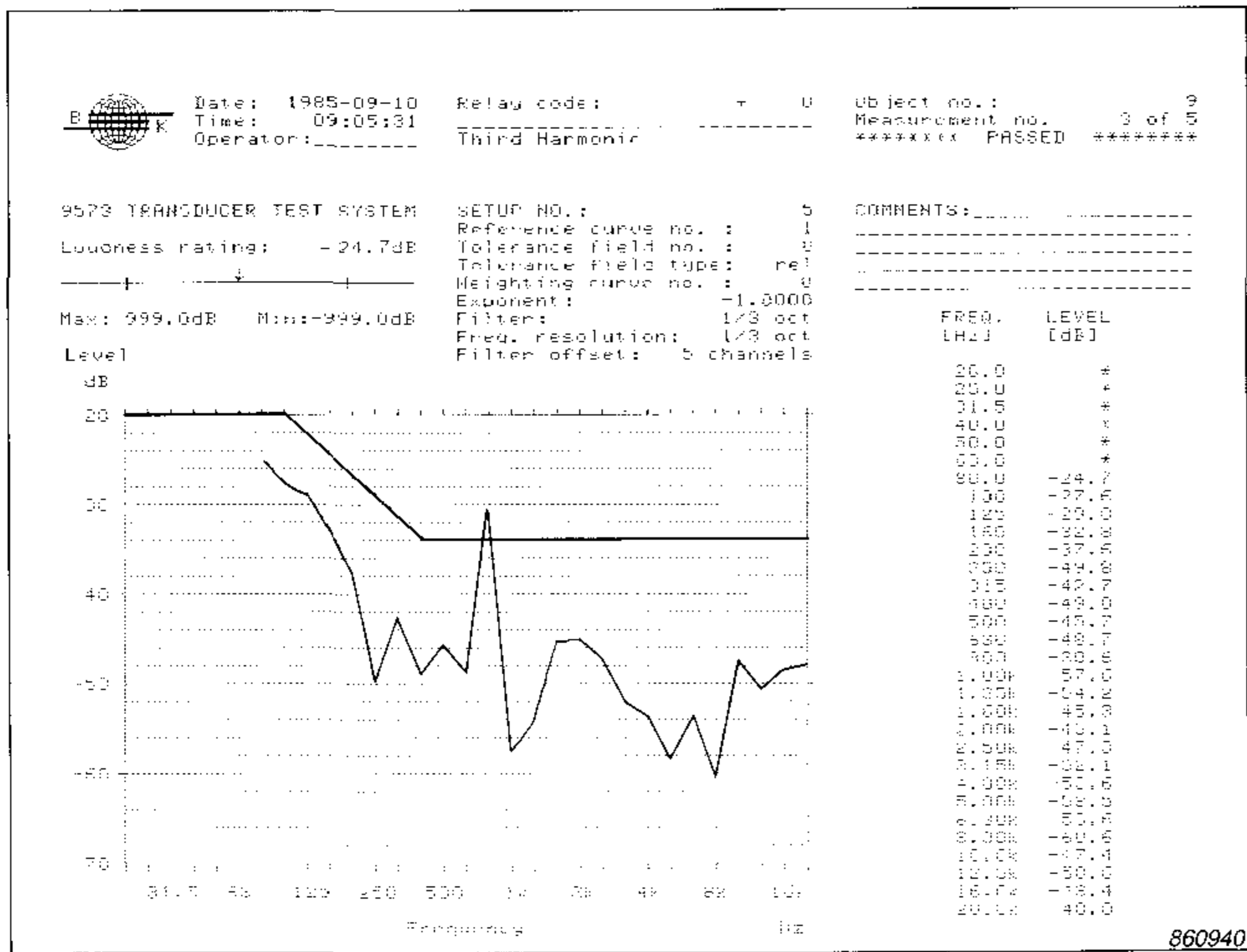

Fig. 21. Same speaker as Fig. 20. 3% 3rd harmonic distortion at 800 Hz

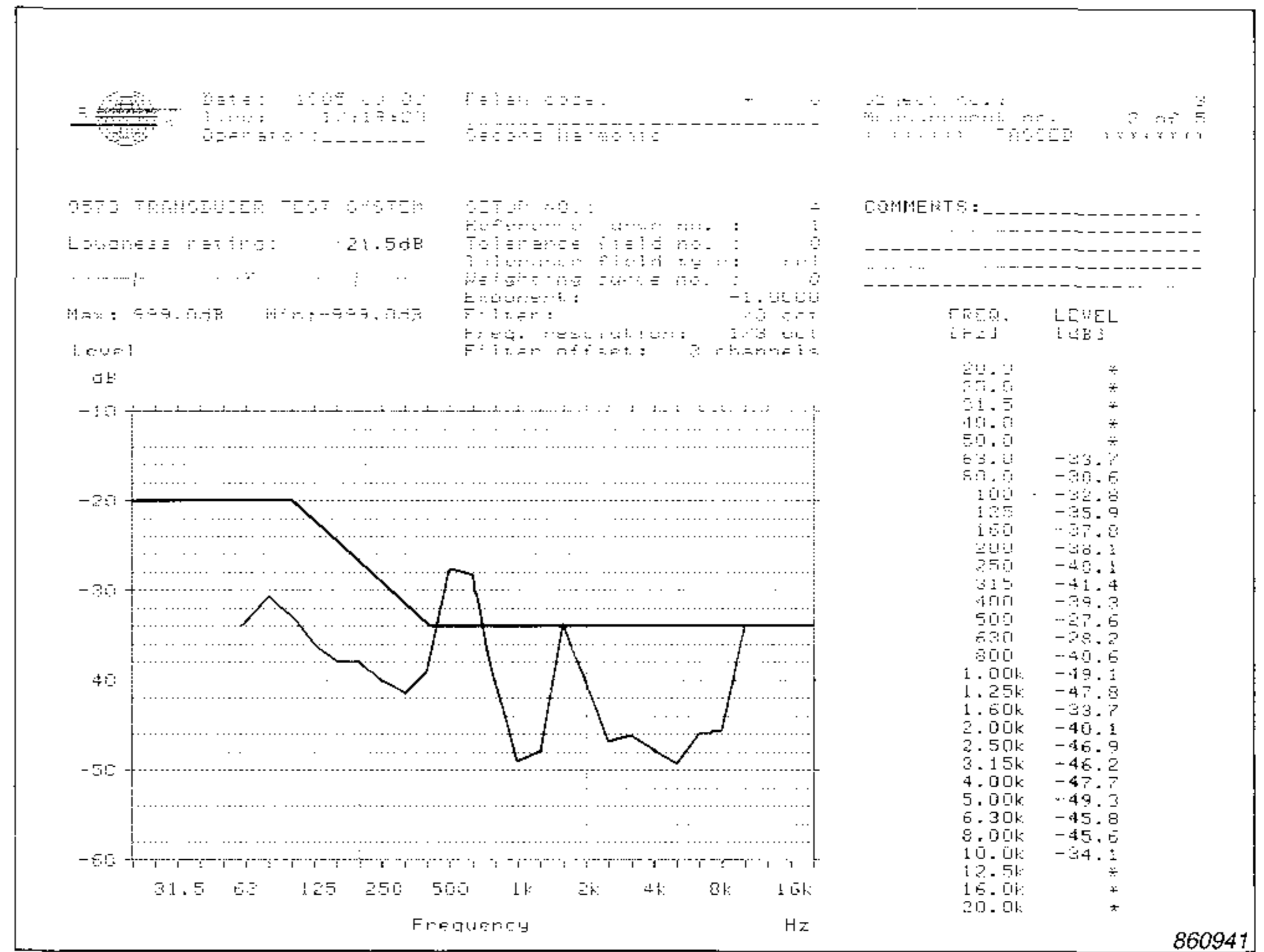

Fig. 22. Audible cone distortion 400-630 Hz. 2nd harmonic distortion 4%

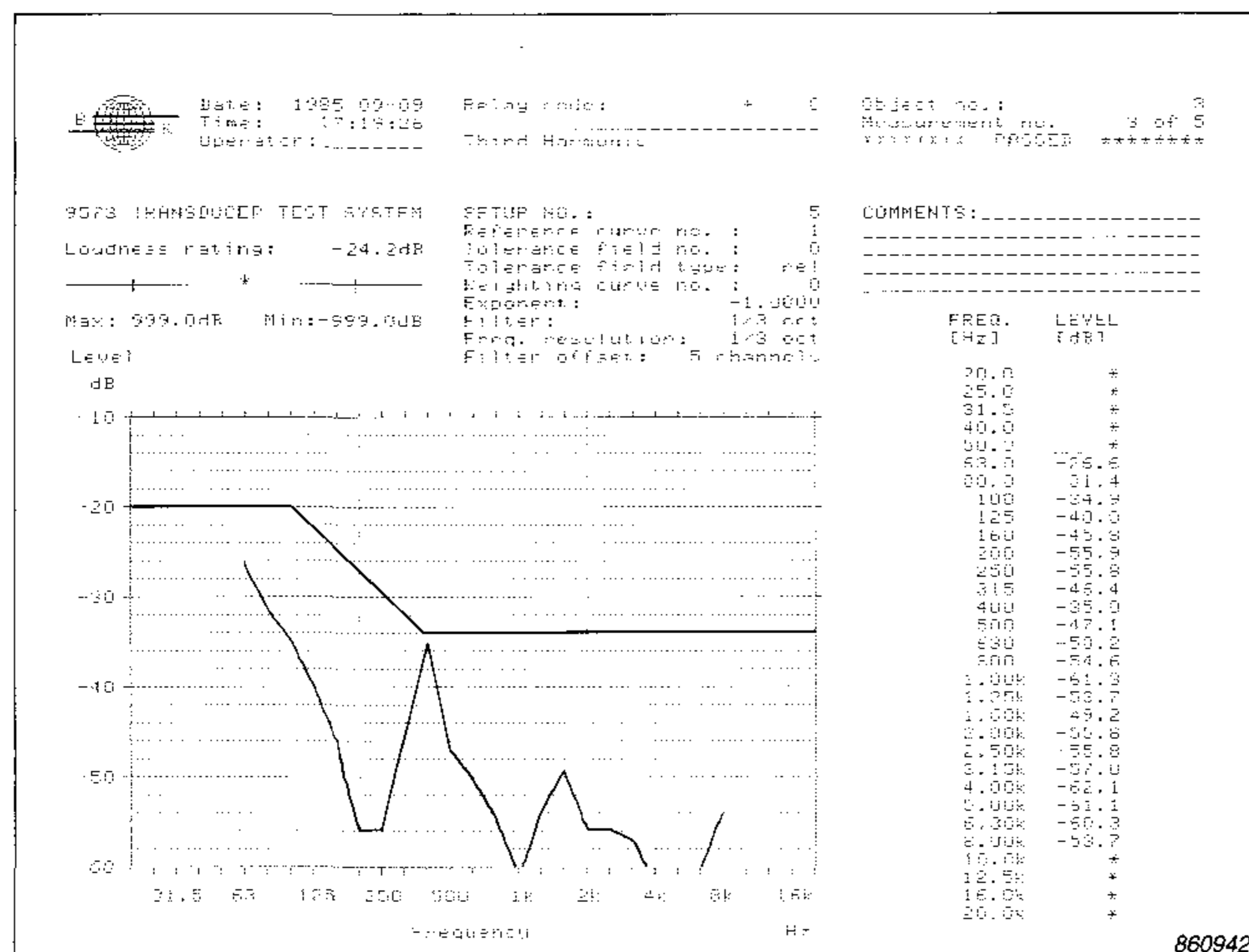

Fig. 23. Same speaker as Fig. 22. 3rd harmonic distortion 2% at 400 Hz

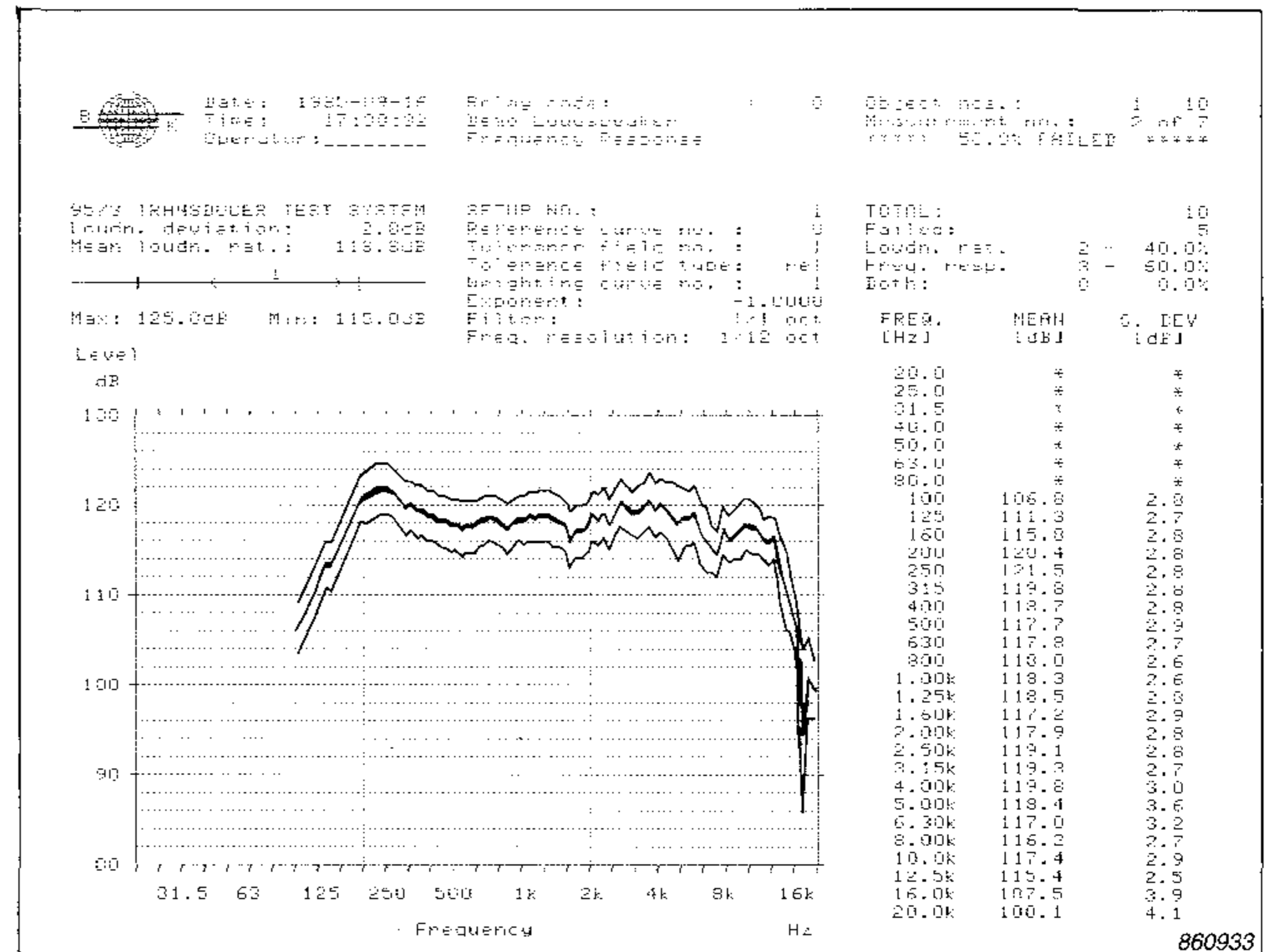

Fig. 24. Statistical data from 10 test runs. Bold curve is mean, light upper and lower curves are one standard deviation

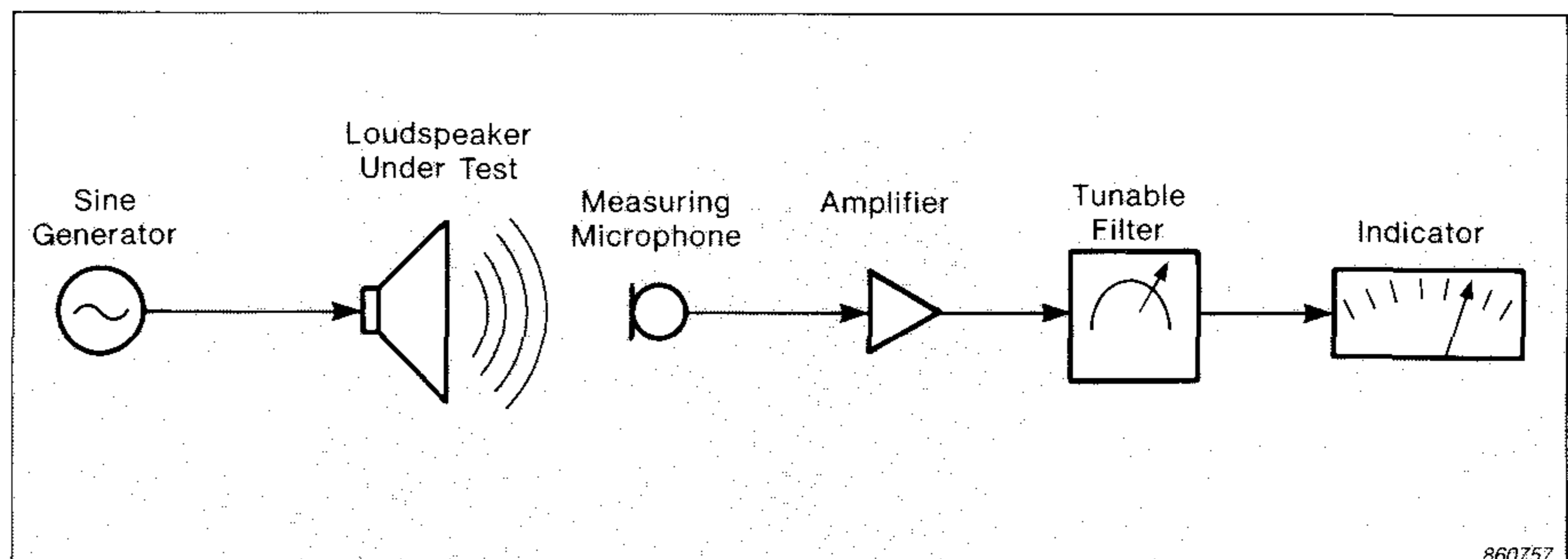

Fig. 25. Basic principle of loudspeaker test system

The fully automated system is shown in Figs. 26 and 27. Control of the system is by the Graphics Recorder Type 2313 in the form of a plug-in application package. The test designer sets up the test sequence from the front panel. The test operator starts the test with a pushbutton or foot-pedal. The test sequence is performed automatically, the results compared against previously defined limits, and

a pass or fail indication given. Print-outs are available either automatically or by front panel command. The measurements in Figs. 4, 5, 9-12, 15-23 and 24 were produced by this system.

In addition to performing the actual test, it is often useful to have a simple statistical summary of measurements made on a large number of devices. Summaries such as shown in Fig. 24

are available for each sub-test in the whole test sequence. They can be requested from the front panel of the 2313 during or at the end of a long test run. In this way it is possible to discover trends in failure rates due to various faults.

A successful loudspeaker quality test sequence will include many separate tests. However, each situation will

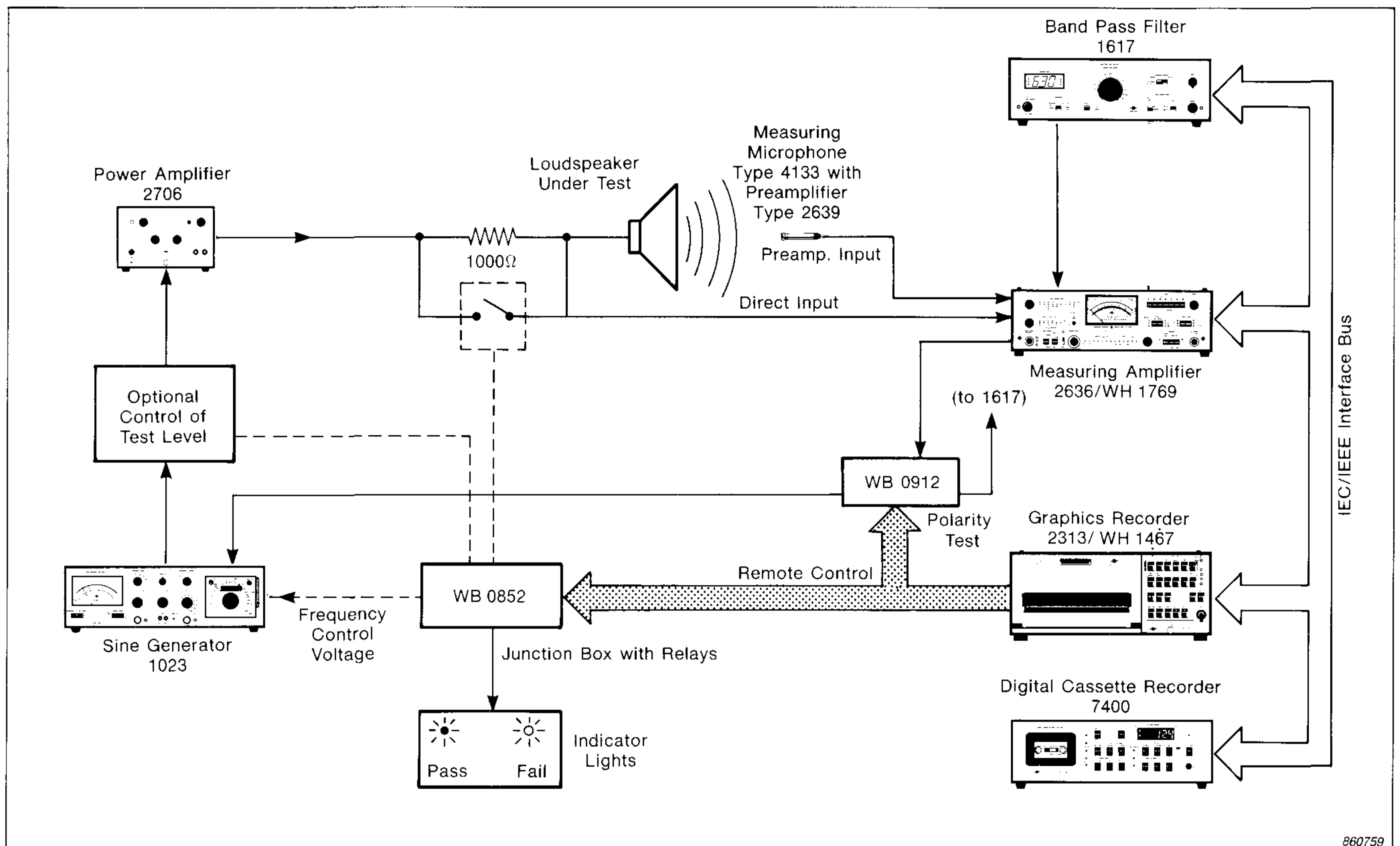

Fig. 26. Block diagram of automated loudspeaker test system

Width (Octaves)	Step Size	Channels Offset	Normalized Center Frequency (Harmonic)	Harmonics in Passband	Residual Distortion	Application
1/3	1/3	0	1	1	0 dB	Noise rejection
1/1	1/3 or 1/12	0	1	1	0 dB	Noise rejection
1/3	1/3	3	2	2	-50 dB	2 nd Harmonic Distortion
1/3	1/3	5	3	3	-65 dB	3 rd Harmonic Distortion
1/1	1/3	4	2,5	2 + 3	-30 dB	"Pseudo" THD
1/3	1/3	9	8	7-9	-75 dB*	Rub + Buzz
1/1	1/3 or 1/12	9	8	6-11	-63 dB	Rub + Buzz
1/1	1/3 or 1/12	12	16	11-22	-75 dB*	Rub + Buzz + Rattle
1/1	1/3 or 1/12	20	100	71-141	-75 dB*	Loose particles

* Approximate

Table 1. Use of filters in Type 9573 Transducer Test System

require a different balance between thoroughness and speed. A rapid screening test can be devised that is practical for every-unit testing. It might include measurements of:

1. Sensitivity (average of 315, 400, 500 Hz)
2. Polarity (400 Hz)
3. Impedance (400 Hz)
4. Rub (at resonance)
5. Loose particles (at resonance)
6. 2nd harmonic distortion (at resonance)
7. 3rd harmonic distortion (at resonance)

The above screening test can be performed in about five seconds by the system in Fig. 26.

A more thorough test appropriate for every-unit testing of premium quality speakers or for sampling tests of standard products might include measurements of:

1. Frequency response (full range, $\frac{1}{3}$ or $\frac{1}{12}$ octave steps)
2. Sensitivity (calculated from 1.)
3. Polarity (at selected frequency)
4. Impedance (near resonance, and at 400 Hz)
5. Rub (at resonance)
6. Loose particles (at resonance)
7. 2nd harmonic distortion (at resonance, and 250–1000 Hz)

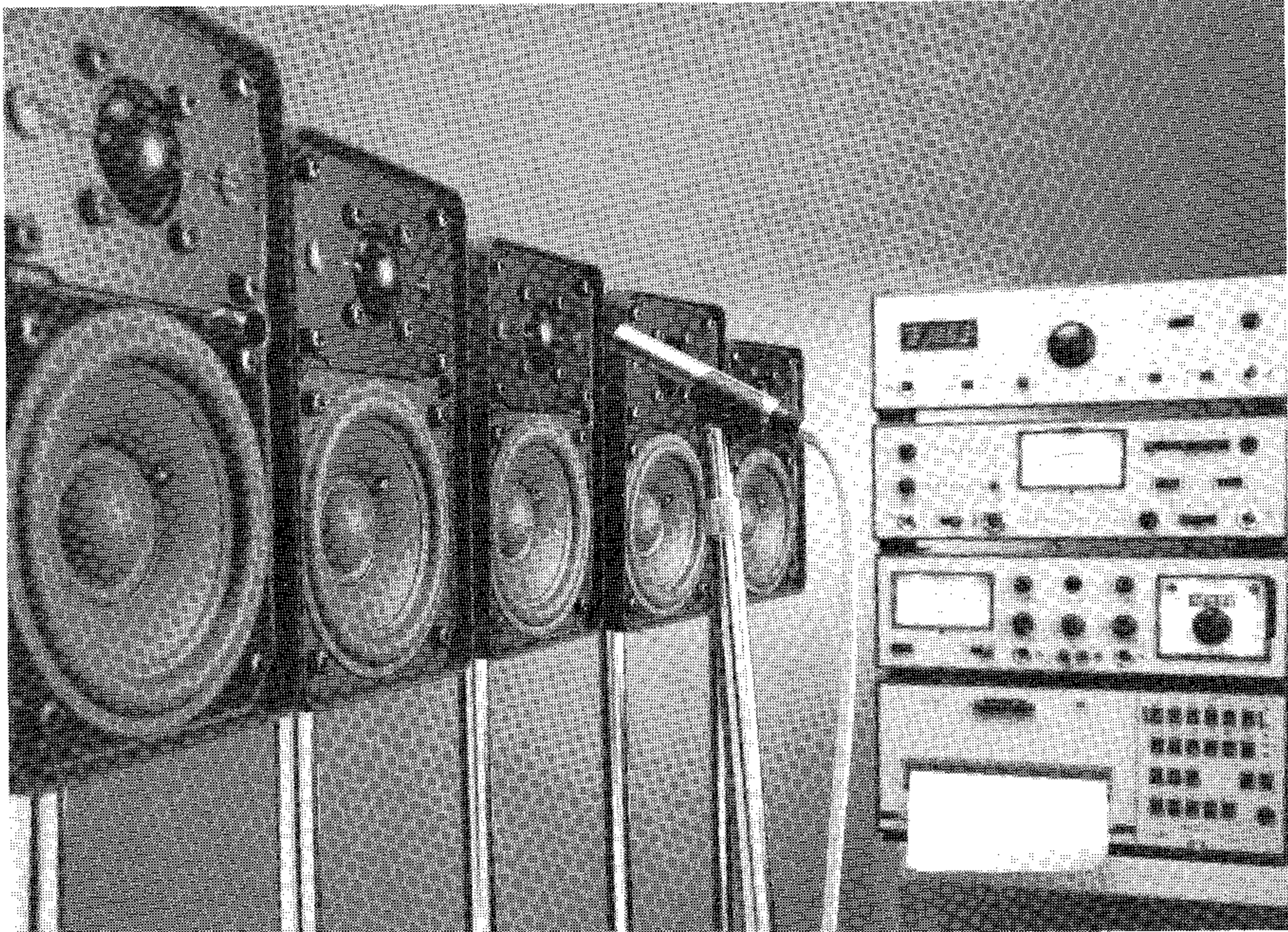

Fig. 27. Transducer Test System Type 9573

8. 3rd harmonic distortion (at resonance, and 250–1000 Hz)

The more complete test will take longer, perhaps from 30–60 seconds if all tests are conducted over the entire range of the loudspeaker. But if the range of some tests is reduced as suggested above, test time can be reduced significantly.

Tests of loudspeaker quality can be successfully performed with automatic instrumentation. A sequence of specific tests can be designed which will detect several likely faults. The exact test parameters should be optimized for each individual loudspeaker design to be tested, but the general guidelines given here are a good place to start.

